

TO-220-3L/TO-220F Plastic-Encapsulate Diodes

SBD10100SCTB、SBDF10100SCTB SCHOTTKY BARRIER RECTIFIER

MAIN CHARACTERISTICS

I_o	10 (2×5) A
V_{RRM}	100 V
T_j	150 °C
$V_{F(typ)}$	0.54V (@ $T_j=125^{\circ}C$)

FEATURES

- Low Power Loss, High Efficiency
- Guard Ring Die Construction for Transient Protection
- High Current Capability and Low Forward Voltage Drop

MARKING

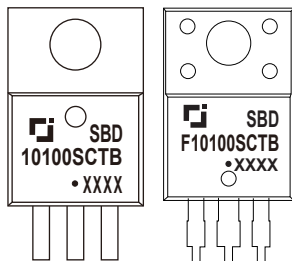

SBD(F)10100SCTB = Device code
 Solid dot = Green molding compound device
 if none, the normal device
 XXXX = Code

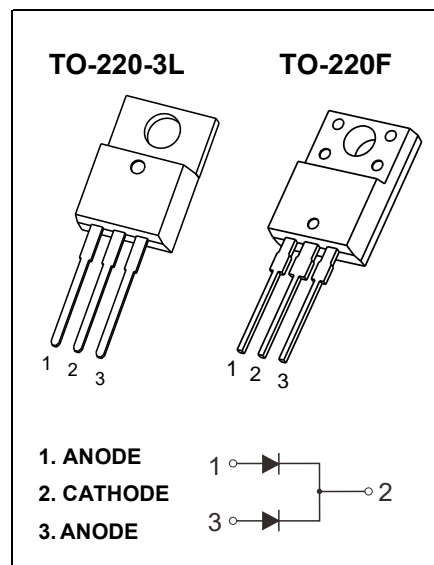

MAXIMUM RATINGS ($T_a=25^{\circ}C$ unless otherwise noted)

Symbol	Parameter	SBD		Unit
		10100SCTB	F10100SCTB	
V_{RRM}	Peak repetitive reverse voltage	100		V
V_{RWM}	Working peak reverse voltage			
V_R	DC blocking voltage			
$V_{R(RMS)}$	RMS reverse voltage	70		V
I_o	Average rectified output current	10		A
I_{FSM}	Non-Repetitive peak forward surge current (8.3ms half sine wave)	150		A
$R_{\theta Jc}$	Thermal resistance from junction to case , $T_c=25^{\circ}C$	2.0	3.0	$^{\circ}C/W$
$R_{\theta JA}$	Thermal resistance from junction to ambient	62.5		$^{\circ}C/W$
T_j	Junction temperature	150		$^{\circ}C$
T_{stg}	Storage temperature	-55~+150		$^{\circ}C$

ELECTRICAL CHARACTERISTICS ($T_a=25^{\circ}C$ unless otherwise specified)

Parameter	Symbol	Test conditions	Min	Typ	Max	Unit
Reverse voltage	$V_{(BR)}$	$I_R=1mA$	100			V
Reverse current	I_R	$V_R=100V$	$T_j=25^{\circ}C$	10.0	100	μA
			$T_j=125^{\circ}C$	5.0		mA
Forward voltage	V_F	$I_F=3A$	$T_j=25^{\circ}C$	0.50		V
			$T_j=125^{\circ}C$	0.45		V
		$I_F=5A$	$T_j=25^{\circ}C$	0.57	0.63	V
			$T_j=125^{\circ}C$	0.54		V

*Pulse test: pulse width $\leq 300\mu s$, duty cycles $\leq 2.0\%$.

Typical Characteristics

FIG.1: FORWARD CURRENT DERATING CURVE

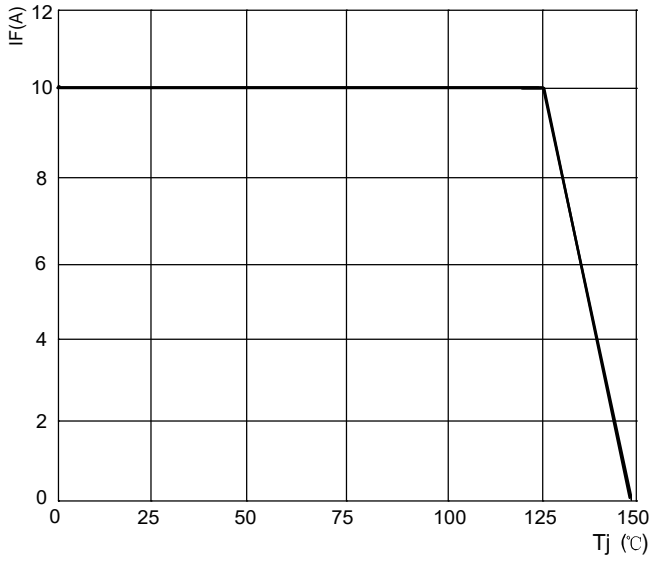

FIG.2: TYPICAL FORWARD CHARACTERISTICS

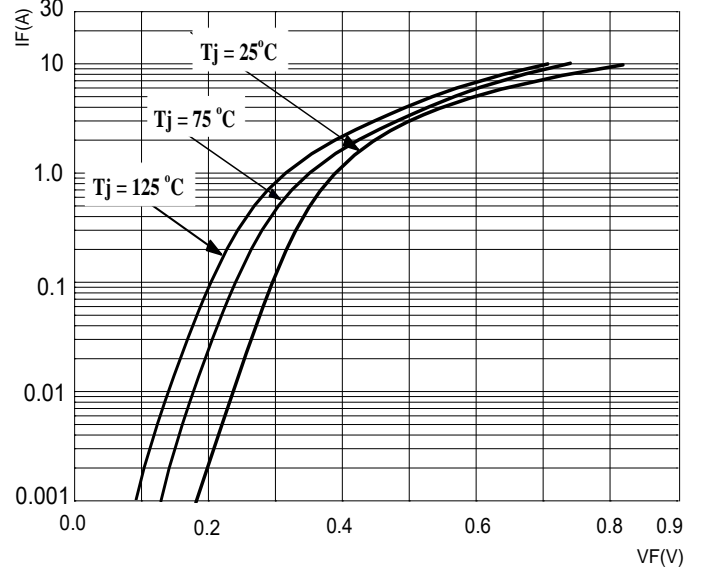

FIG.3: TOTAL CAPACITANCE DERATING CURVE

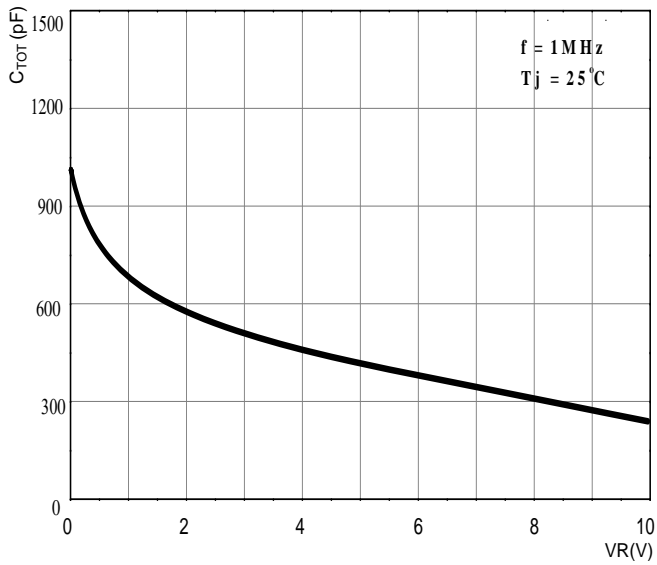
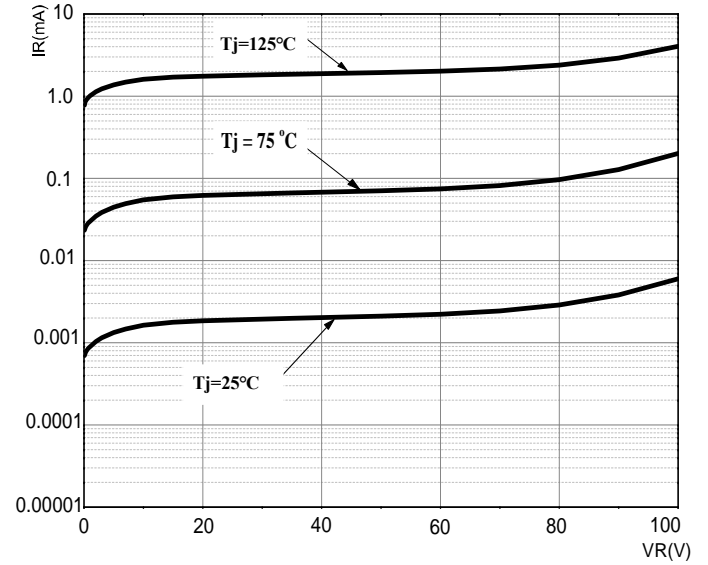
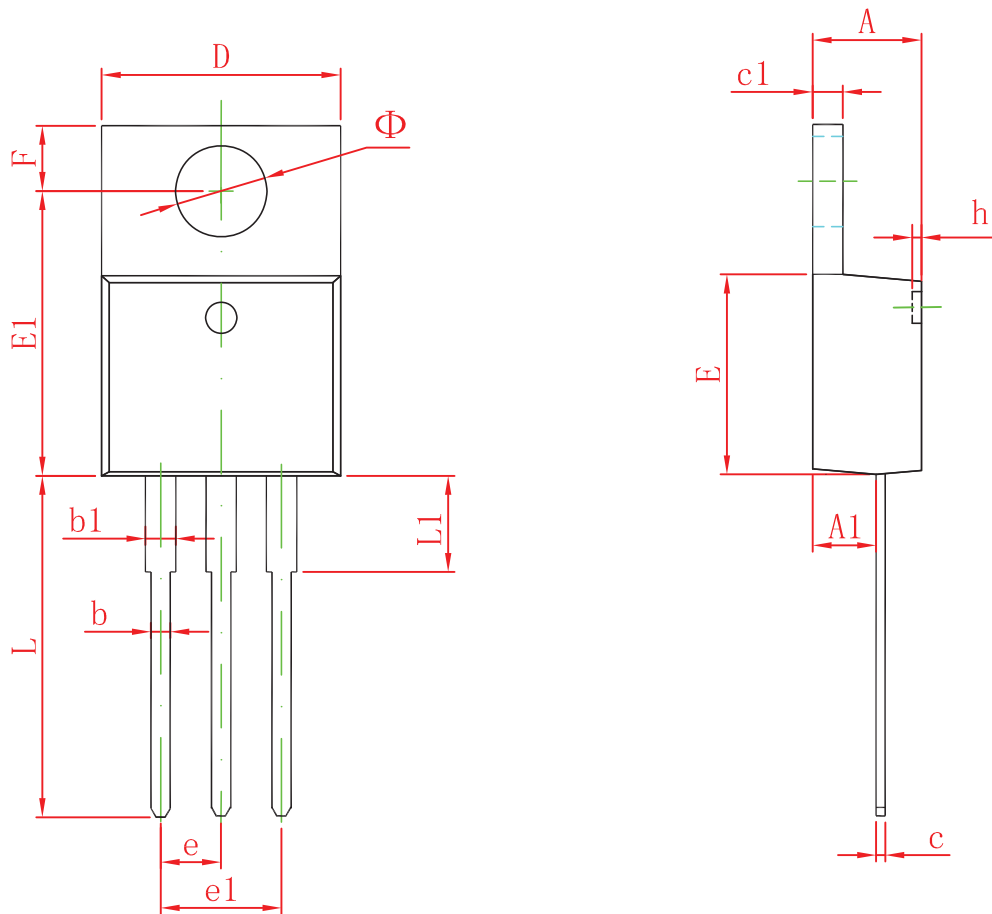

FIG.4: TYPICAL REVERSE CHARACTERISTICS



TO-220-3L Package Outline Dimensions



Symbol	Dimensions In Millimeters		Dimensions In Inches	
	Min	Max	Min	Max
A	4.450	4.750	0.175	0.187
A1	2.520	2.820	0.099	0.111
b	0.710	0.910	0.028	0.036
b1	1.170	1.370	0.046	0.054
c	0.300	0.500	0.012	0.020
c1	1.170	1.370	0.046	0.054
D	9.830	10.330	0.387	0.407
E	8.500	8.900	0.335	0.350
E1	12.050	12.650	0.474	0.498
e	2.540 TYP		0.100 TYP	
e1	4.900	5.200	0.192	0.205
F	2.540	2.940	0.100	0.116
h	0.100 TYP		0.004 TYP	
L	13.300	13.800	0.523	0.543
L1	3.540	3.940	0.139	0.155
Φ	3.735	3.935	0.147	0.155

TO-220F Package Outline Dimensions



Symbol	Dimensions In Millimeters		Dimensions In Inches	
	Min.	Max.	Min.	Max.
A	4.300	4.700	0.169	0.185
A1	1.300 REF.		0.051 REF.	
A2	2.800	3.200	0.110	0.126
A3	2.500	2.900	0.098	0.114
b	0.500	0.750	0.020	0.030
b1	1.100	1.350	0.043	0.053
b2	1.500	1.750	0.059	0.069
c	0.500	0.750	0.020	0.030
D	9.960	10.360	0.392	0.408
E	14.800	15.200	0.583	0.598
e	2.540 TYP.		0.100 TYP.	
F	2.700 REF.		0.106 REF.	
Φ	3.500 REF.		0.138 REF.	
h	0.000	0.300	0.000	0.012
h1	0.800 REF.		0.031 REF.	
h2	0.500 REF.		0.020 REF.	
L	28.000	28.400	1.102	1.118
L1	1.700	1.900	0.067	0.075
L2	1.900	2.100	0.075	0.083