

LESD11LV12CT5G Transient Voltage Suppressors

ESD Protection Diodes with Ultra-Low Capacitance

The ESD11LV is designed to protect voltage sensitive components that require ultra-low capacitance from ESD and transient voltage events. Excellent clamping capability, low capacitance, low leakage, and fast response time, make these parts ideal for ESD protection on designs where board space is at a premium. Because of its low capacitance, it is suited for use in high frequency designs such as USB 2.0 high speed and antenna line applications.

Specification Features:

- Ultra Low Capacitance 1.5 pF
- Low Clamping Voltage
- Small Body Outline Dimensions:
(0.61 mm x 0.31 mm)
- Low Body Height: 0.28 mm
- Stand-off Voltage: 10 V
- Low Leakage
- Response Time is Typically < 1.0 ns
- IEC61000-4-2 Level 4 ESD Protection
- This is a Pb-Free Device

Mechanical Characteristics:

CASE: Void-free, transfer-molded, thermosetting plastic Epoxy Meets UL 94 V-0

LEAD FINISH: 100% Matte Sn (Tin)

MAXIMUM RATINGS

Rating	Symbol	Value	Unit
IEC 61000-4-2 (ESD) Contact Air		±10 ±15	kV
Total Power Dissipation on FR-5 Board (Note 1) @ T _A = 25°C	P _D	200	mW
Storage Temperature Range	T _{stg}	-55 to +150	°C
Junction Temperature Range	T _J	-55 to +150	°C
Lead Solder Temperature - Maximum (10 Second Duration)	T _L	260	°C

Stresses exceeding Maximum Ratings may damage the device. Maximum Ratings are stress ratings only. Functional operation above the Recommended Operating Conditions is not implied. Extended exposure to stresses above the Recommended Operating Conditions may affect device reliability.

1. FR-5 = 1.0 x 0.75 x 0.62 in.

LESD11LV12CT5G

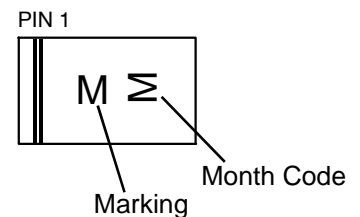
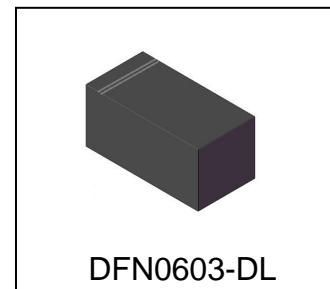

Device	Marking	Shipping
LESD11LV12CT5G	M	15000/Tape&Reel

LESD11LV12CT5G

ELECTRICAL CHARACTERISTICS

(T_A = 25°C unless otherwise noted)

Symbol	Parameter
I _{PP}	Maximum Reverse Peak Pulse Current
V _C	Clamping Voltage @ I _{PP}
V _{RWM}	Reverse standoff voltage
I _R	Maximum Reverse Leakage Current @ V _{RWM}
V _{BR}	Breakdown Voltage @ I _T
I _T	Test Current
V _{TRIG}	Reverse trigger voltage
I _{TRIG}	Reverse trigger current

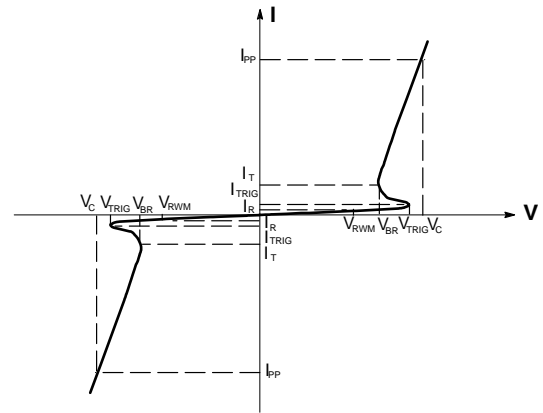

Bi-Directional TVS

ELECTRICAL CHARACTERISTICS (T_A = 25°C unless otherwise noted)

Device	Device Marking	V _{RWM} (V)	I _R (μA) @ V _{RWM}	V _{BR} (V) @ I _T (Note 2)	I _T	C (pF)	V _C (V) @ I _{PP} = 1.65 A (Note 3)	V _C
		Max	Max	Min	mA	Max	Max	Per IEC61000-4-2 (Note 4)
LESD11LV12CT5G	M	10	1.0	12	1.0	1.8	24.5	Figures 1 and 2 See Below

- V_{BR} is measured with a pulse test current I_T at an ambient temperature of 25°C.
- Surge current waveform per Figure 4.
- For test procedure see Figures 3.

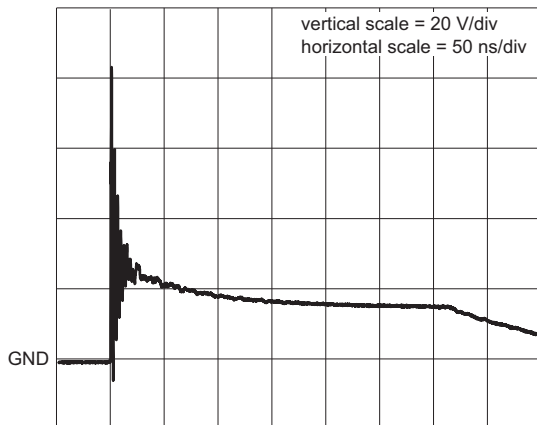

Figure 1. ESD Clamping Voltage Screenshot Positive 8 kV Contact per IEC61000-4-2

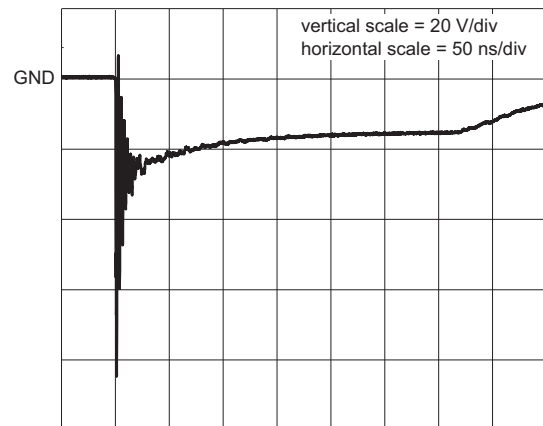

Figure 2. ESD Clamping Voltage Screenshot Negative 8 kV Contact per IEC61000-4-2

LESD11LV12CT5G

IEC 61000-4-2 Spec.

Level	Test Voltage (kV)	First Peak Current (A)	Current at 30 ns (A)	Current at 60 ns (A)
1	2	7.5	4	2
2	4	15	8	4
3	6	22.5	12	6
4	8	30	16	8

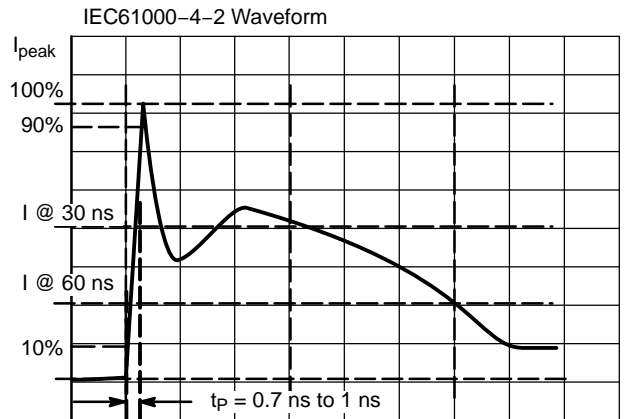

Figure 3. IEC61000-4-2 Spec

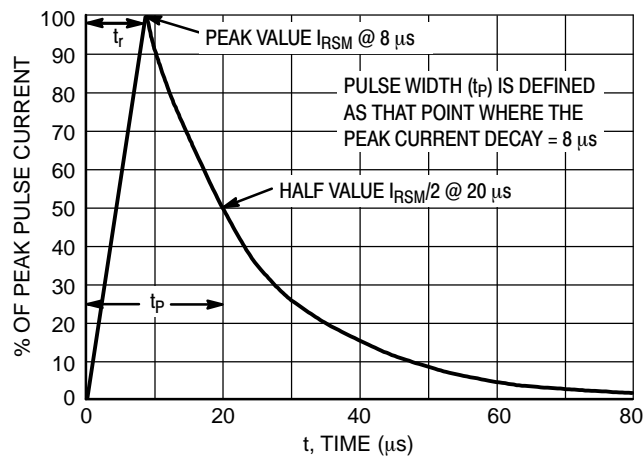
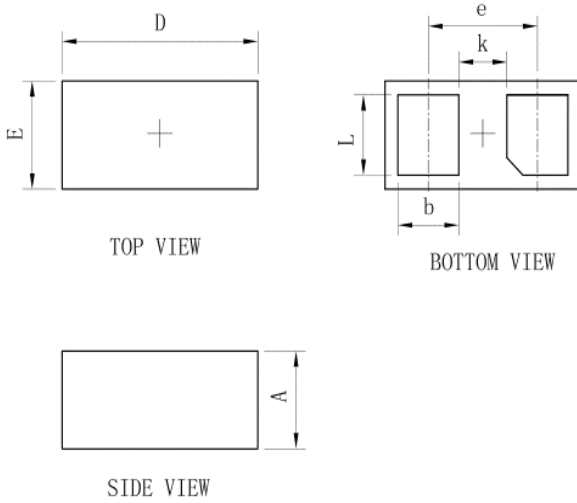

Figure 4. 8 X 20 μs Pulse Waveform

LESD11LV12CT5G

OUTLINE AND DIMENSIONS



DFN0603-DL			
Dim	Min	Typ.	Max
D	0.58	0.61	0.64
E	0.28	0.31	0.34
e	-	0.34	-
L	0.20	0.23	0.26
b	0.16	0.19	0.22
A	0.25	0.28	0.31
k	0.12	0.15	0.18
All Dimensions in mm			

SOLDERING FOOTPRINT

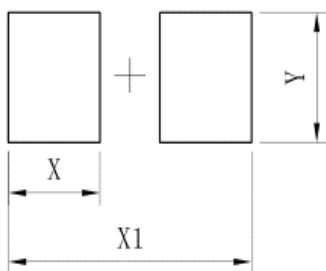

DFN0603-DL	
DIM	(mm)
X	0.23
X1	0.61
Y	0.30

DISCLAIMER

- Before you use our Products, you are requested to carefully read this document and fully understand its contents. LRC shall not be in any way responsible or liable for failure, malfunction or accident arising from the use of any LRC's Products against warning, caution or note contained in this document.
- All information contained in this document is current as of the issuing date and subject to change without any prior notice. Before purchasing or using LRC's Products, please confirm the latest information with a LRC sales representative.