

LN2308SLT1G

60V N-Channel (D-S) MOSFET

1. FEATURES

- $V_{DS} = 60V$
- $R_{DS(ON)}, V_{GS}@10V \leq 100m\Omega$
- $R_{DS(ON)}, V_{GS}@4.5V \leq 120m\Omega$
- We declare that the material of product compliance with RoHS requirements and Halogen Free.

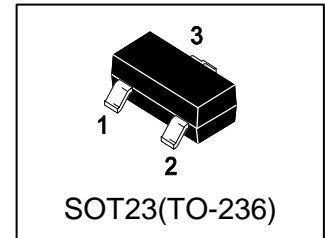

2. APPLICATIONS

- Load/Power switch for portables and computing
- DC-DC conversion

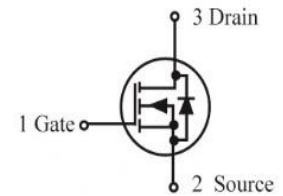

3. DEVICE MARKING AND ORDERING INFORMATION

Device	Marking	Shipping
LN2308SLT1G	08S	3000/Tape&Reel

4. MAXIMUM RATINGS($T_a = 25^\circ C$)

Parameter	Symbol	Limits	Unit
Drain-Source Voltage	V_{DS}	60	V
Gate-to-Source Voltage – Continuous	V_{GS}	± 20	V
Drain Current			
– Continuous $T_A = 25^\circ C$	I_D	2.5	A
– Pulsed(Note 1)	I_{DM}	10	

5. THERMAL CHARACTERISTICS

Parameter	Symbol	Limits	Unit
Maximum Power Dissipation	PD	1.25	W
Thermal Resistance, Junction-to-Ambient(Note 2)	$R_{\theta JA}$	100	$^\circ C/W$
Junction and Storage temperature	T_J, T_{stg}	$-55 \sim +150$	$^\circ C$

1. Repetitive Rating: Pulse width limited by the Maximum junction temperature.

2. 1-in² 2oz Cu PCB board.

6. ELECTRICAL CHARACTERISTICS (Ta= 25°C)

Characteristic	Symbol	Min.	Typ.	Max.	Unit	
Static						
Drain–Source Breakdown Voltage (VGS = 0 V, ID = 250 μA)	V(BR)DSS	60	-	-	V	
Zero Gate Voltage Drain Current (VDS= 60 V, VGS= 0 V)	IDSS	-	-	1	μA	
Gate–Body Leakage Current (VDS = 0 V, VGS = ± 20 V)	IGSS	-	-	±100	nA	
Gate Threshold Voltage (VDS = VGS, ID = 250 μA)	VGS(th)	1	1.5	3	V	
Static Drain–Source On–State Resistance(Note 3) (VGS = 10 V, ID = 1.5 A) (VGS = 4.5 V, ID = 1 A)	RDS(on)	-	-	100 120	mΩ	
Diode Forward Voltage (VGS = 0 V, IS = 1 A)	VSD	-	-	1.2	V	
Dynamic						
Input Capacitance	(VDS = 30 V, VGS = 0 V, f= 1MHz)	Ciss	-	394	-	pF
Output Capacitance		Coss	-	23	-	
Reverse Transfer Capacitance		Crss	-	17.5	-	
Total Gate Charge	(VDS = 30 V, VGS = 4.5 V, ID = 1.5 A)	Qg	-	4.3	-	nC
Gate-Source Charge		Qgs	-	1	-	
Gate-Drain Charge		Qgd	-	1.9	-	
Turn-On Delay Time	(VDS = 30 V, ID = 2 A, VGS = 4.5 V, RG = 6Ω)	td(on)	-	8.2	-	ns
Rise Time		tr	-	8.6	-	
Turn-Off Delay Time		td(off)	-	16.1	-	
Fall Time		tf	-	5.7	-	

3.Pulse Test: Pulse Width ≤300 μs, Duty Cycle ≤2.0%.

7. ELECTRICAL CHARACTERISTICS CURVES

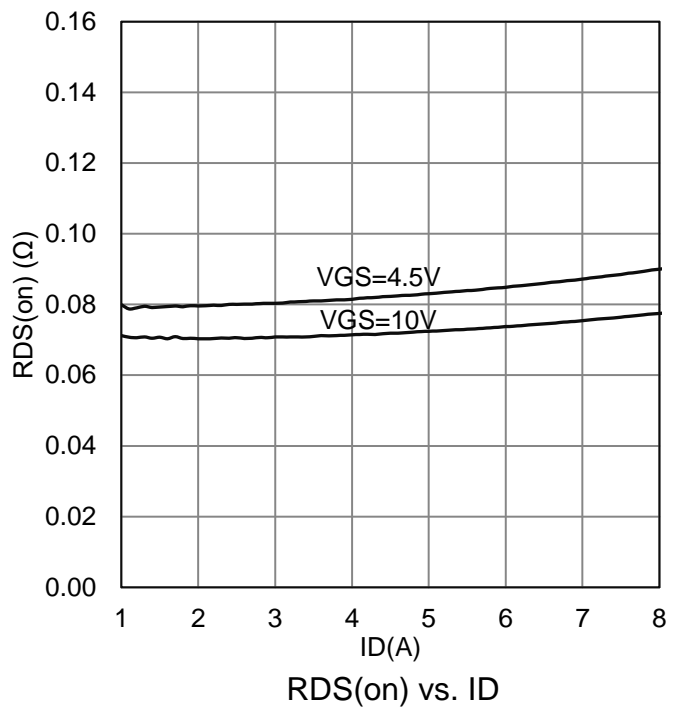
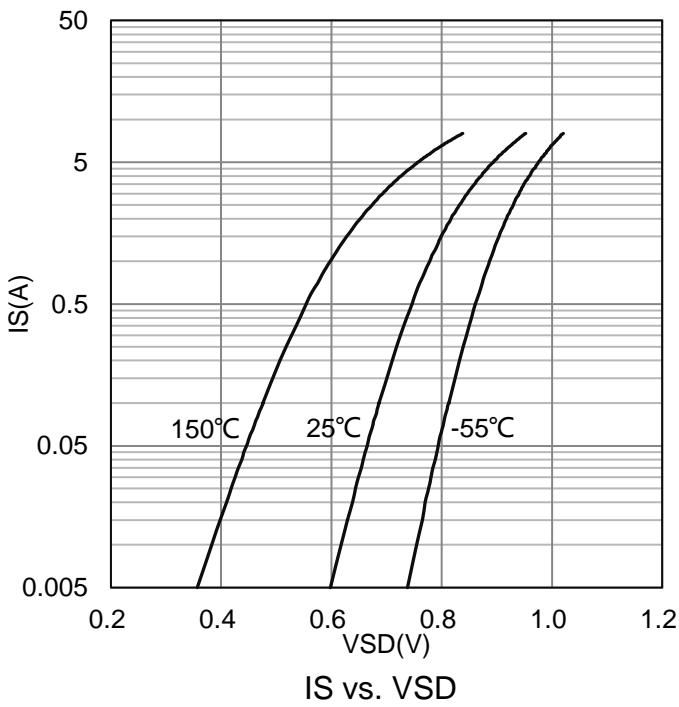
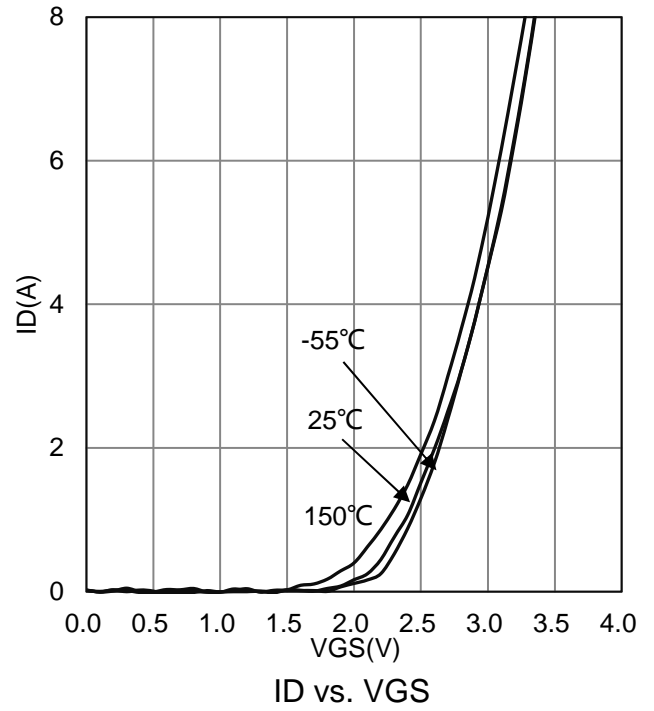
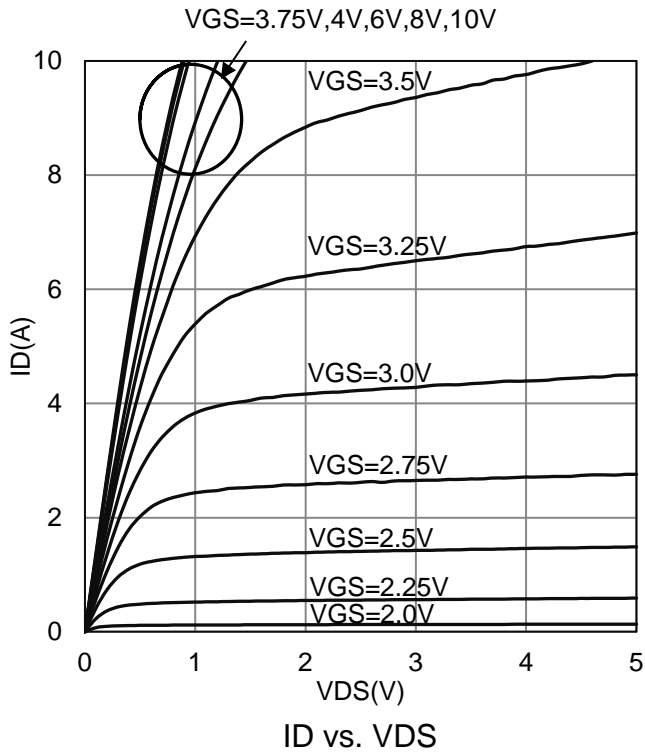

7. ELECTRICAL CHARACTERISTICS CURVES(Con.)

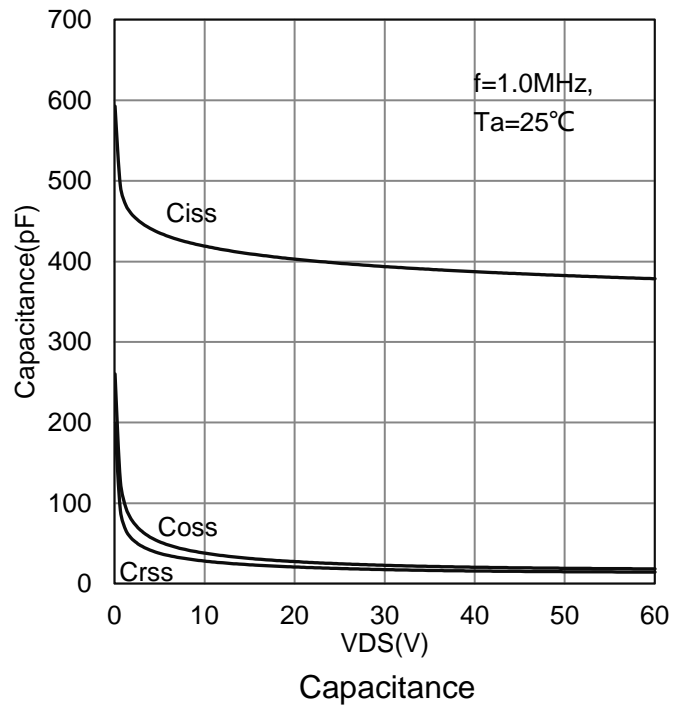
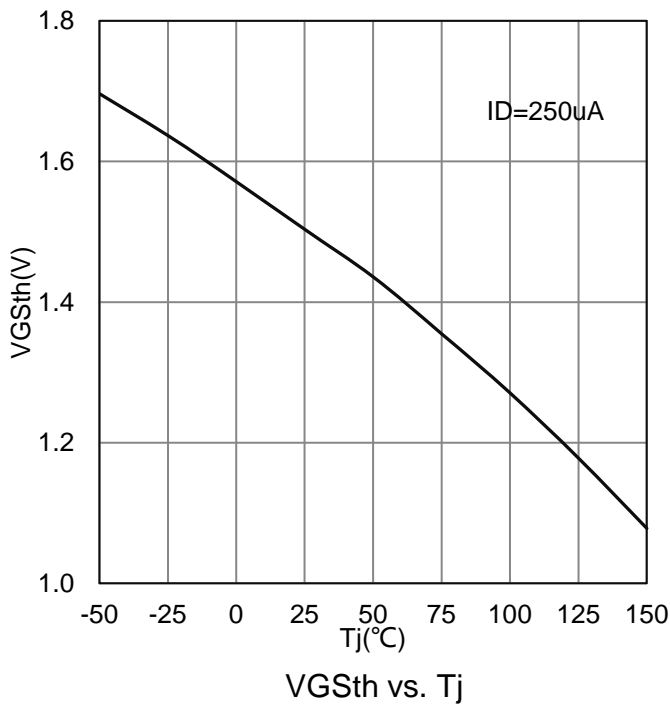
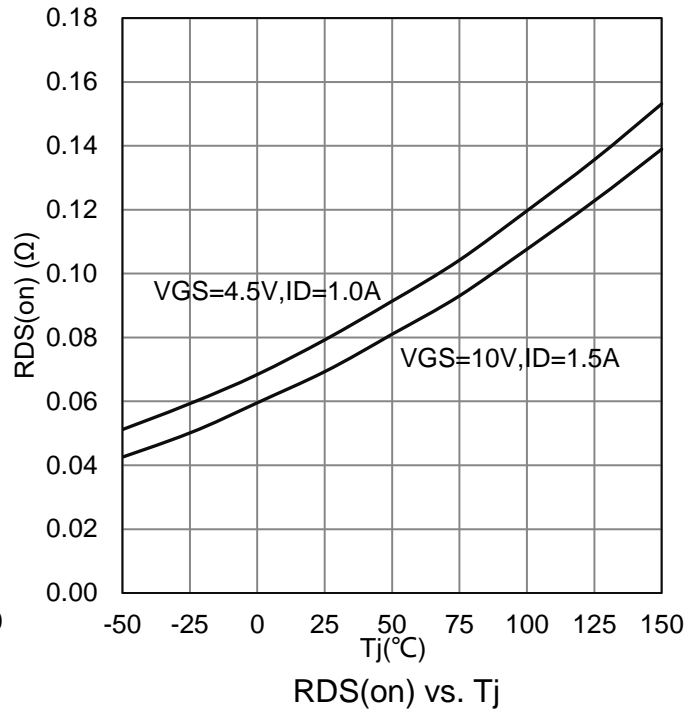
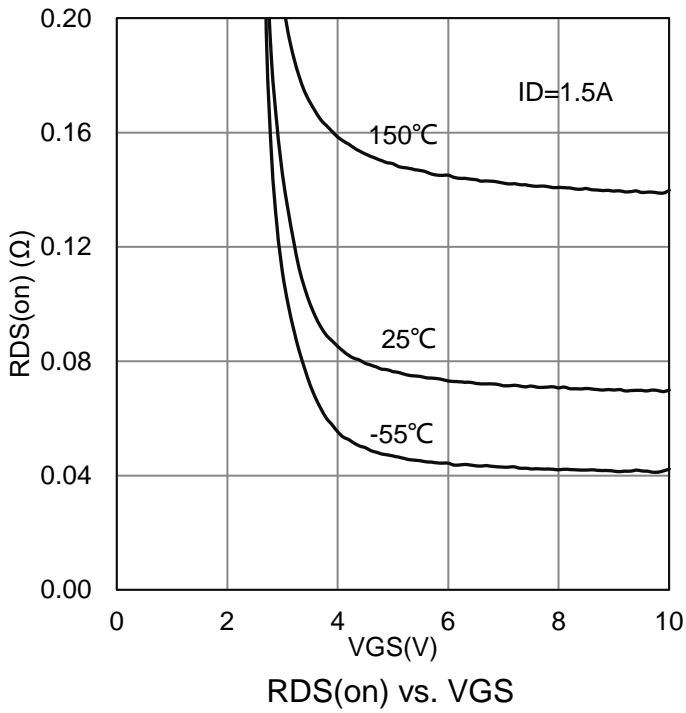

7. ELECTRICAL CHARACTERISTICS CURVES(Con.)

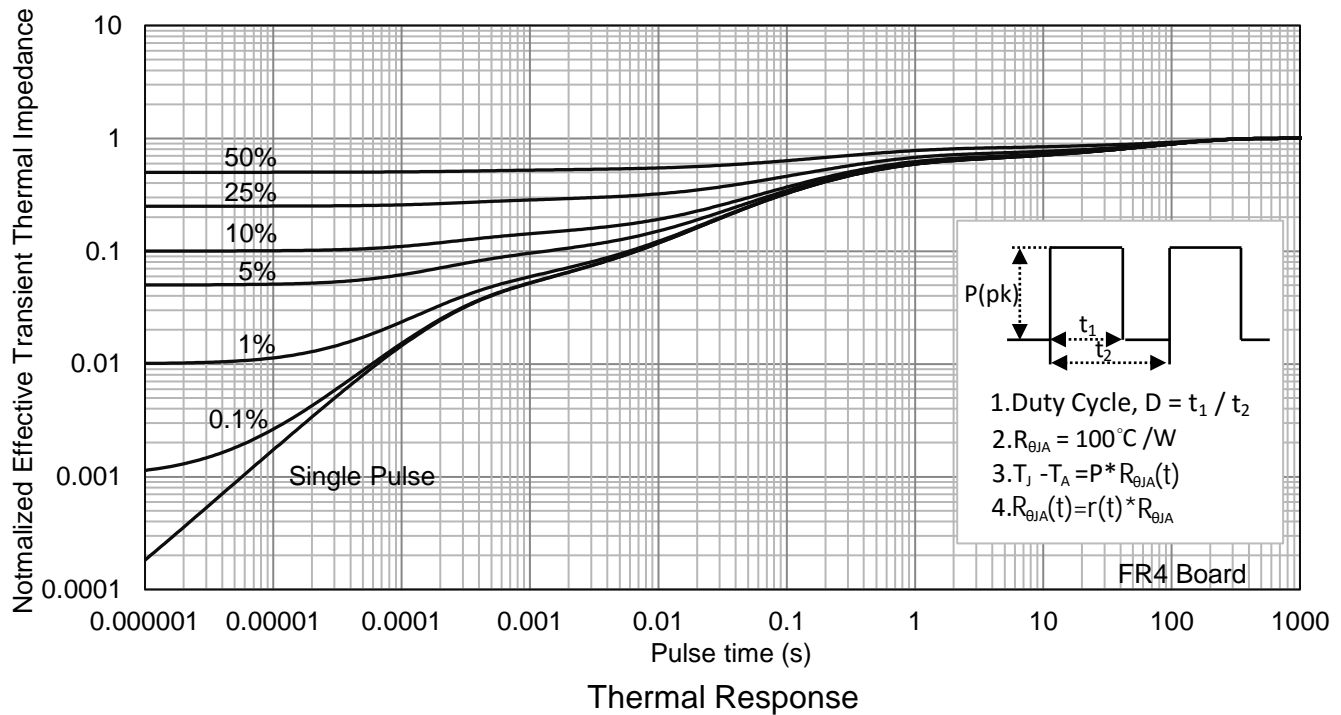
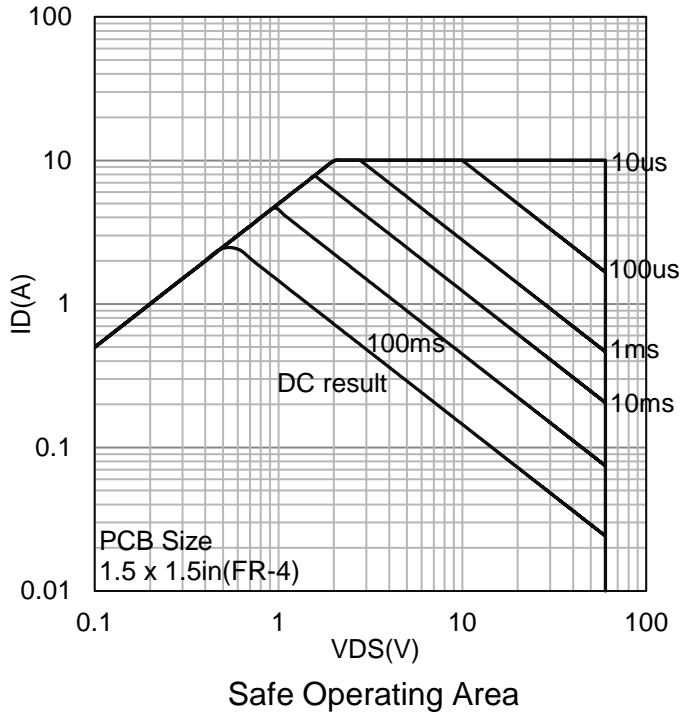

8. OUTLINE AND DIMENSIONS

SOT23E

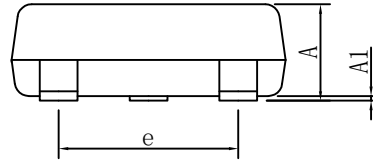
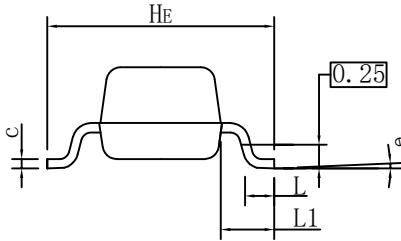

SOT23E			
DIM	MIN	NOR	MAX
A	0.90	1.00	1.10
A1	0.01	0.06	0.10
b	0.30	0.40	0.50
c	0.10	0.17	0.20
D	2.80	2.90	3.00
E	1.20	1.30	1.40
e	1.80	1.90	2.00
L	0.20	0.40	0.60
L1	0.60REF		
HE	2.20	2.40	2.60
θ	0°	-	10°
All Dimensions in mm			

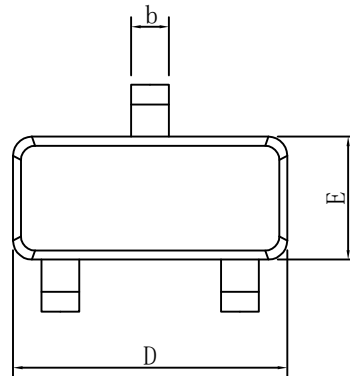

GENERAL NOTES

1. Top package surface finish Ra0.4±0.2um
2. Bottom package surface finish Ra0.7±0.2um
3. Side package surface finish Ra0.4±0.2um

9. SOLDERING FOOTPRINT

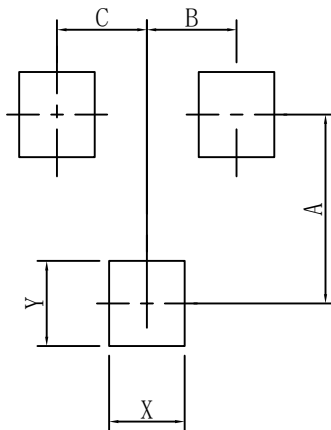

SOT23E	
DIM	(mm)
X	0.80
Y	0.90
A	2.00
B	0.95
C	0.95

DISCLAIMER

- Curve guarantee in the specification. The curve of test items with electric parameter is used as quality guarantee. The curve of test items without electric parameter is used as reference only.
- Before you use our Products for new Project, you are requested to carefully read this document and fully understand its contents. LRC shall not be in any way responsible or liable for failure, malfunction or accident arising from the use of any LRC's Products against warning, caution or note contained in this document.
- All information contained in this document is current as of the issuing date and subject to change without any prior notice. Before purchasing or using LRC's Products, please confirm the latest information with a LRC sales representative.