

General Description

The SY6288 is an ultra-low $R_{DS(ON)}$ switch with current limitation function to protect the power source from over current and short circuit conditions.

Ordering Information

SY6288□(□□)□

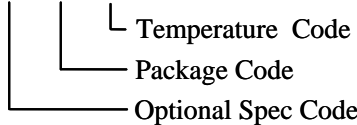

Ordering Number	Package Type	UL certified	TUV certified
SY6288AAAC	SOT23-5	YES	YES
SY6288ACAC	MSOP8	YES	YES
SY6288AFAC	SO8	YES	YES
SY6288A1AAC	SOT23-5	YES	YES
SY6288BAAC	SOT23-5	YES	YES
SY6288BCAC	MSOP8	YES	YES
SY6288BFAC	SO8	YES	YES
SY6288CAAC	SOT23-5	YES	YES
SY6288C30AAC	SOT23-5	YES	YES
SY6288CFAC	SO8	YES	YES
SY6288CCAC	MSOP8	YES	YES
SY6288C1CAC	MSOP8	YES	YES
SY6288C4CAC	MSOP8	YES	YES
SY6288C5CAC	MSOP8	YES	YES
SY6288C30CAC	MSOP8	YES	YES
SY6288DAAC	SOT23-5	YES	YES
SY6288D1AAC	SOT23-5	YES	YES
SY6288D30AAC	SOT23-5	YES	YES
SY6288DCAC	MSOP8	YES	YES
SY6288D1CAC	MSOP8	YES	YES
SY6288D5CAC	MSOP8	YES	YES
SY6288DFAC	SO8	YES	YES
SY6288D1FAC	SO8	YES	YES

Features

- Distribution Voltages: 2.5V to 5.5V
- Over Temperature Shutdown and Automatic Retry
- Reverse Blocking (No Body Diode)
- At Shutdown, OUT can be Forced Higher than IN
- Fault Flag (OCB) Output if Over Current, Thermal Shut Down or Reverse Blocking Happens
- Automatic Output Discharge at Shutdown
 - SY6288A1: No Output Discharge Function
 - Others: Auto Output Discharge Function
- Built-in Soft-start
- 0.4ms Rise Time
- RoHS Compliant and Halogen Free
- Two Enable Polarities and Three Current Levels
 - SY6288A: Active High/0.6A
 - SY6288A1: Active High/0.6A
 - SY6288B: Active Low/0.6A
 - SY6288C: Active High/2A
 - SY6288C1: Active High/1.5A
 - SY6288C30: Active High/2A
 - SY6288C4: Active High/2A
 - SY6288C5: Active High/2.5A
 - SY6288D: Active Low/2A
 - SY6288D1: Active Low/1.5A
 - SY6288D5: Active Low/2.5A
 - SY6288D30: Active Low/2A
- Compact Packages Minimize the Board Space: SOT23-5, SO8, MSOP8
- TUV Certification NO. R 50188769
- UL Certification NO. E491480
- CB Certification by IEC 62368-1

Typical Application Circuit

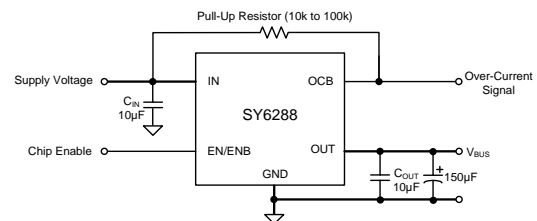

Note: A low-ESR 150µF aluminum electrolytic or tantalum between VOUT and GND is strongly recommended.

Pin Configurations (Top View)

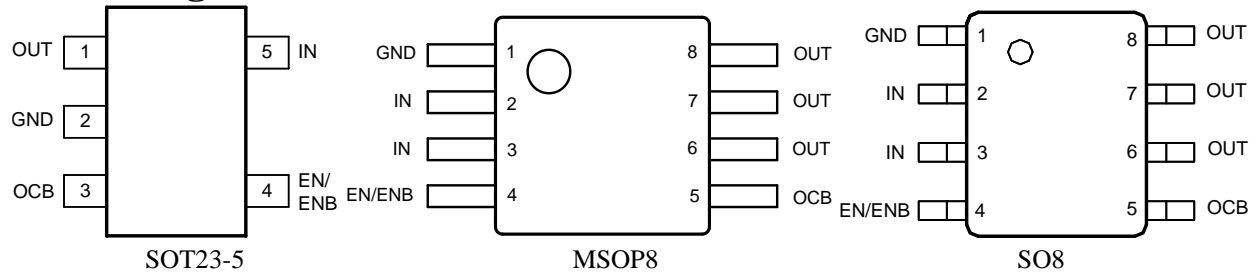

Part Number	Package type	Top Mark ^①
SY6288AAAC	SOT23-5	CW _{xyz}
SY6288ACAC	MSOP8	ABT _{xyz}
SY6288AFAC	SO8	AAJ _{xyz}
SY6288A1AAC	SOT23-5	Fd _{xyz}
SY6288BAAC	SOT23-5	DB _{xyz}
SY6288BCAC	MSOP8	ABD _{xyz}
SY6288BFAC	SO8	AAL _{xyz}
SY6288CAAC	SOT23-5	DF _{xyz}
SY6288C30AAC	SOT23-5	Br _{xyz}
SY6288CCAC	MSOP8	ABU _{xyz}
SY6288C1CAC	MSOP8	ADK _{xyz}
SY6288C4CAC	MSOP8	AEX _{xyz}
SY6288C5CAC	MSOP8	AZD _{xyz}
SY6288C30CAC	MSOP8	ARW _{xyz}
SY6288CFAC	SO8	AAM _{xyz}
SY6288DAAC	SOT23-5	BU _{xyz}
SY6288D1AAC	SOT23-5	DS _{xyz}
SY6288D30AAC	SOT23-5	Bq _{xyz}
SY6288DCAC	MSOP8	ABE _{xyz}
SY6288D1CAC	MSOP8	ACK _{xyz}
SY6288D5CAC	MSOP8	AZE _{xyz}
SY6288DFAC	SO8	AAN _{xyz}
SY6288D1FAC	SO8	ACJ _{xyz}

Note ①: x=year code, y=week code, z=lot number code.

Functional Pin Description

Pin Name	Pin Number (SO8, MSOP8)	Pin Number (SOT23-5)	Pin Description
IN	2,3	5	Input pin.
GND	1	2	Ground pin.
OUT	6,7,8	1	Output pin.
EN- SY6288A/A1/C/C1 /C30/C4/C5 ENB-SY6288B/D1/D5/D30	4	4	ON/OFF control. Don't float. EN: high enable. ENB: low enable.
OCB	5	3	Open-drain fault flag.

Absolute Maximum Ratings (Note 1)

IN, OUT, OCB, EN/ENB	-----	-0.3V to 6V
Power Dissipation, P_D @ $T_A = 25^\circ\text{C}$ SOT23-5/MSOP8/SO8	-----	1/0.66/1.11W
Package Thermal Resistance (Note 2)		
SOT23-5/MSOP8/SO8, θ_{JA}	-----	100/150/90°C/W
SOT23-5/MSOP8/SO8, θ_{JC}	-----	30/65/45°C/W
Junction Temperature Range	-----	-40°C to 150°C
Lead Temperature (Soldering, 10 sec.)	-----	260°C
Storage Temperature Range	-----	-65°C to 150°C

Recommended Operating Conditions (Note 3)

IN	-----	2.5V to 5.5V
EN/ENB	-----	-0.3V to $V_{IN}+0.3V$
OUT, OCB	-----	0-5.5V
Junction Temperature Range	-----	-40°C to 125°C
Ambient Temperature Range	-----	-40°C to 85°C

Block Diagram

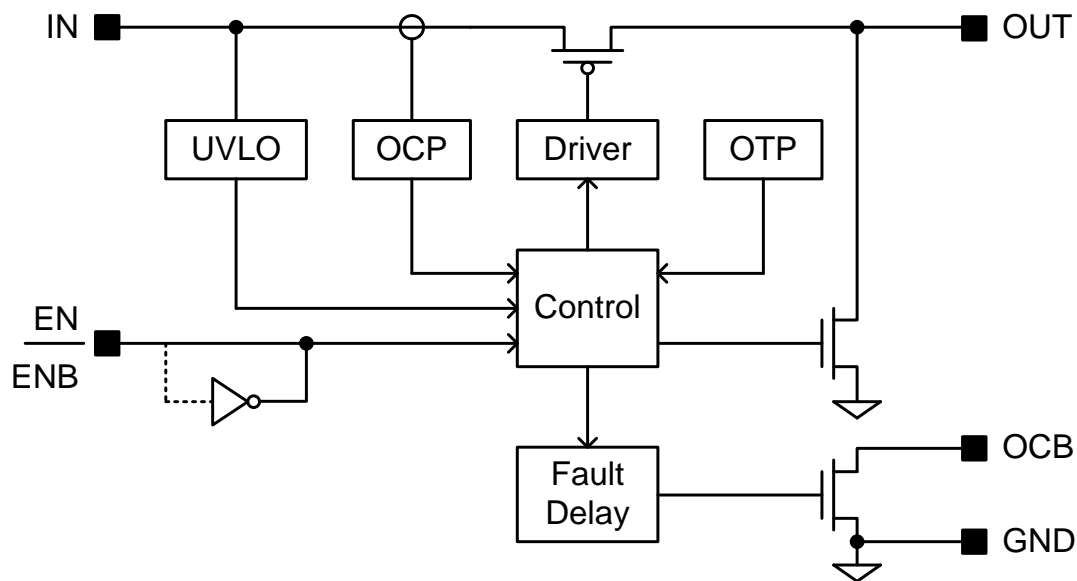

Figure1. Block Diagram



Electrical Characteristics

($V_{IN} = 5V$, $C_L = 1\mu F$, per channel, $T_A = 25^\circ C$ unless otherwise specified)

Parameter	Symbol	Test Conditions	Min	Typ	Max	Unit
Input Voltage Range	V_{IN}		2.5		5.5	V
Shutdown Input Current	I_{SHDN}	Open load, switch off		0.1	1	μA
		Output grounded, switch off		0.1	1	μA
Quiescent Supply Current	I_Q	Open load, switch on		32		μA
FET R_{ON}	$R_{DS(ON)}$	SOT23-5 (SY6288A/B/C/D/D1)	60	80	100	$m\Omega$
		SOT23-5(SY6288A1/C30/D30)	50	70	90	$m\Omega$
		MSOP8 (SY6288A/B/C/C1/C4)	60	80	100	$m\Omega$
		MSOP8(SY6288C5/D1 /D5)	50	70	90	$m\Omega$
		MSOP8 (SY6288C30/D)	57	70	83	$m\Omega$
		SO8(SY6288A/B/C/D/D1)	65	85	105	$m\Omega$
Current Limit	I_{LIM}	SY6288A/A1/B	0.8	1.2	1.6	A
		SY6288C/C30/D/D30	2.1	2.9	3.7	A
		SY6288C1	1.6	2.4	3.2	A
		SY6288D1	1.6	2.5	3.7	A
		SY6288C4	2.5	2.9	3.7	A
		SY6288C5/D5	2.7	3.55	4.4	A
Short Circuit Output Current	I_{OS}	MSOP8 (SY6288D), OUT connected to GND, device enabled	1.2	1.8	2.4	A
EN/ \overline{EN} Threshold	Logic-Low Voltage	V_{IL}			0.8	V
	Logic-High Voltage	V_{IH}	2			V
IN UVLO Threshold	$V_{IN,UVLO}$				2.4	V
IN UVLO Hysteresis	$V_{IN,HYS}$			0.1		V
Turn-ON Time	t_{ON}	$R_L = 5\ \Omega$, $C_L = 1\mu F$		400		μs
OCB Low Resistance	R_{OCB}			10		Ω
OCB Delay Time	t_{OCB_DELAY}			10		ms
OUT Shutdown Discharge Resistance	R_{DIS}	Except for SY6288A1		10		Ω
Thermal Shutdown Temperature	T_{SD}			150		$^\circ C$
Thermal Shutdown Hysteresis				20		$^\circ C$

Note 1: Stresses beyond the “Absolute Maximum Ratings” may cause permanent damage to the device. These are stress ratings only. Functional operation of the device at these or any other conditions beyond those indicated in the operational sections of the specification is not implied. Exposure to absolute maximum rating conditions for extended periods may affect the device reliability.

Note 2: θ_{JA} is measured in the natural convection at $T_A = 25^\circ C$ on a high effective single layer thermal conductivity test board of JEDEC 51-3 thermal measurement standard.

Note 3: The device is not guaranteed to function outside its operating conditions.

SOT23-5 Package Outline & PCB Layout

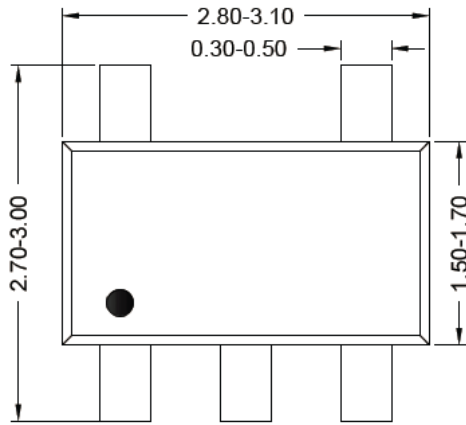

Top view

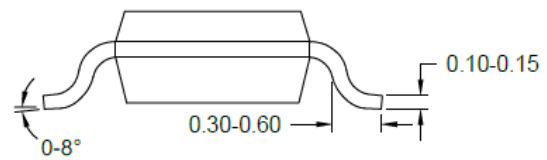

Side view

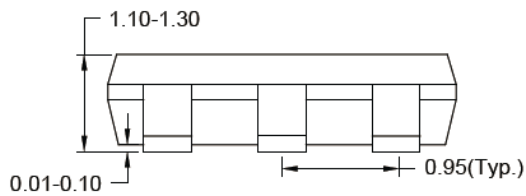

Front view

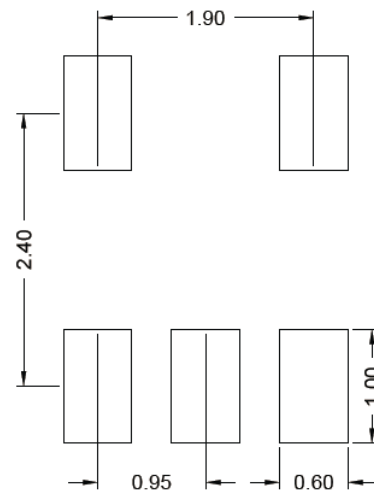

Recommended Pad Layout

Notes: All dimension in millimeter and exclude mold flash & metal burr.

SO8 Package Outline & PCB Layout Design

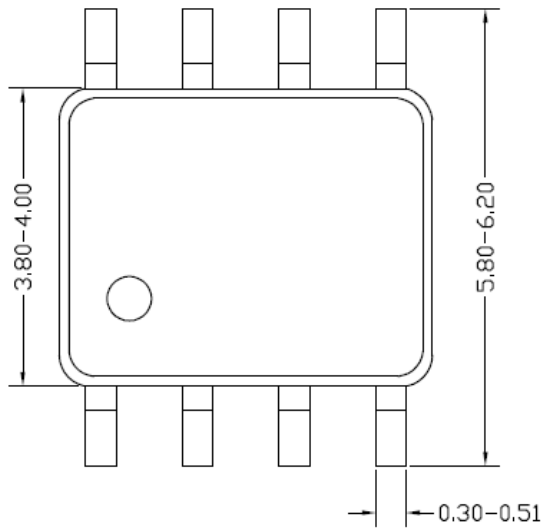

Top view

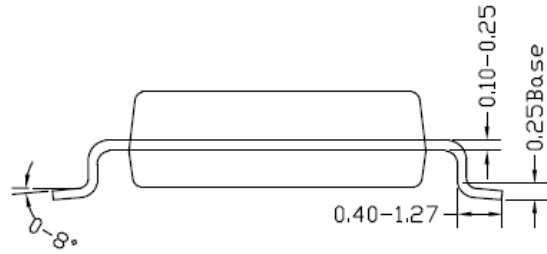

Side view

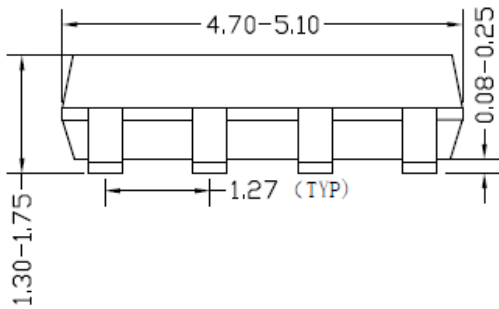

Front view

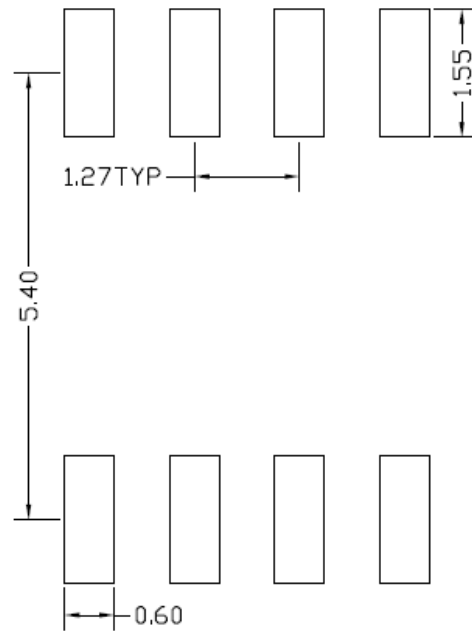

**Recommended Pad Layout
(Reference only)**

Notes: All dimension in millimeter and exclude mold flash & metal burr.

MSOP8 Package Outline & PCB Layout

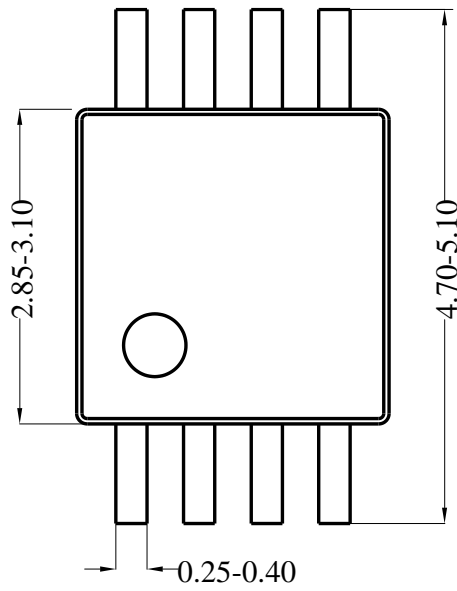

Top View

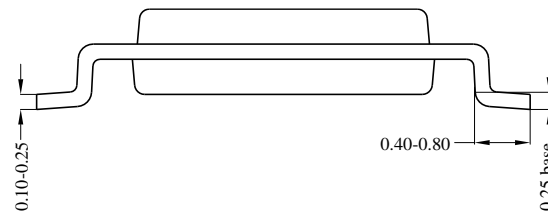

Side View A

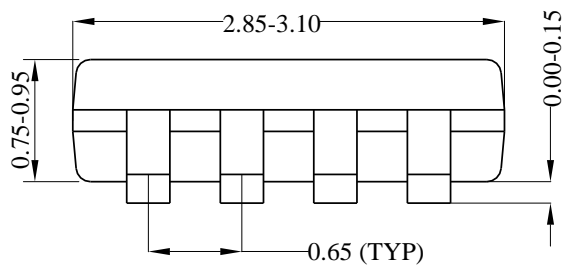

Side View B

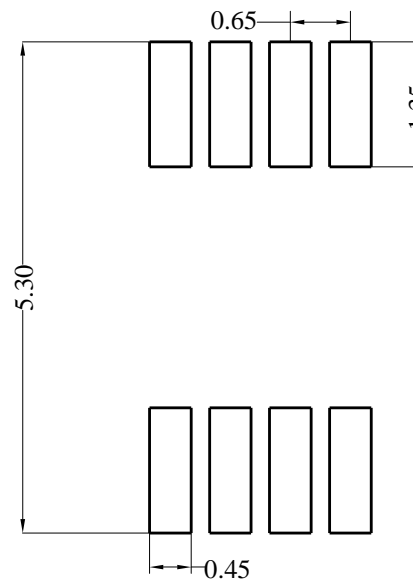

Recommended Pad Layout

Notes: All dimension in millimeter and exclude mold flash & metal burr.

Taping & Reel Specification

1. Taping orientation

SOT23-5

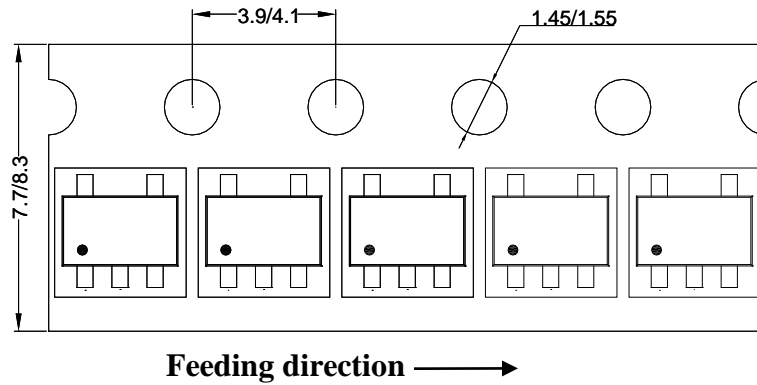

SOP8

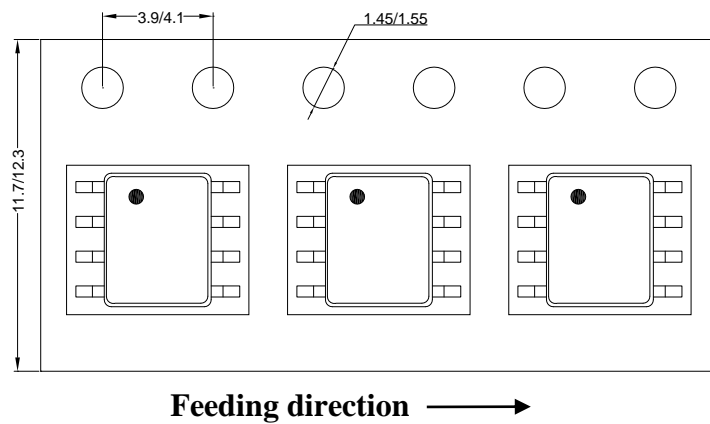

MSOP8

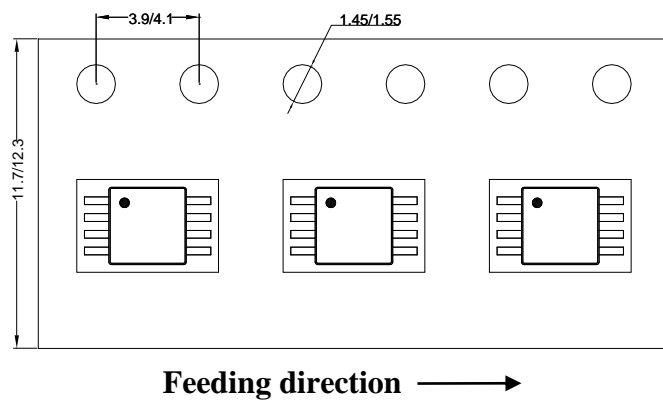

2. Carrier Tape & Reel Specification for Packages

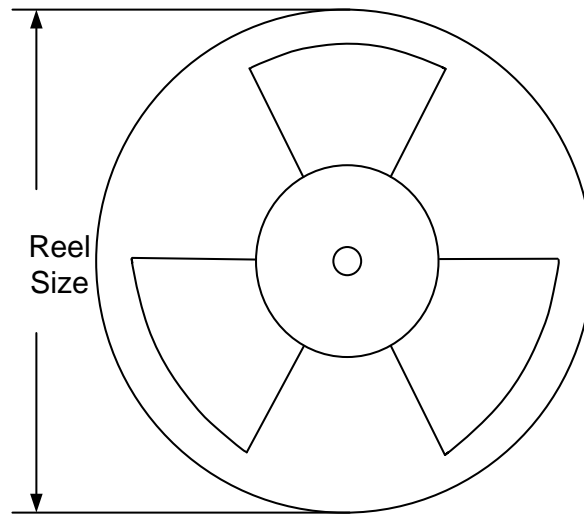

Package types	Tape width (mm)	Pocket pitch(mm)	Reel size (Inch)	Reel width(mm)	Trailer length(mm)	Leader length (mm)	Qty per reel
SOT23-5	8	4	7"	8.4	280	160	3000
SOP8	12	8	13"	12.4	400	400	2500
MSOP8	12	8	13"	12.4	400	400	3000

3. Others: NA