



DSR2A THRU DSR2M

Surface Mount Standard Rectifiers

Reverse Voltage - 50 to 1000 V

Forward Current - 2 A

FEATURES

- For surface mounted applications
- Low profile package
- Glass Passivated Chip Junction
- Ideal for automated placement
- Lead free in comply with EU RoHS 2011/65/EU directives

MECHANICAL DATA

- Case: SOD-123FL
- Terminals: Solderable per MIL-STD-750, Method 2026
- Approx. Weight: 15mg 0.00048oz

PINNING

PIN	DESCRIPTION
1	Cathode
2	Anode

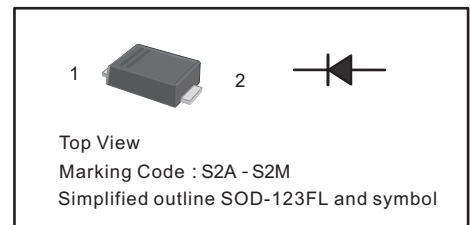

Maximum Ratings and Electrical characteristics

Ratings at 25 °C ambient temperature unless otherwise specified.

Single phase half-wave 60 Hz, resistive or inductive load, for capacitive load current derate by 20 %.

Parameter	Symbols	DSR2A	DSR2B	DSR2D	DSR2G	DSR2J	DSR2K	DSR2M	Units
Maximum Repetitive Peak Reverse Voltage	V_{RRM}	50	100	200	400	600	800	1000	V
Maximum RMS voltage	V_{RMS}	35	70	140	280	420	560	700	V
Maximum DC Blocking Voltage	V_{DC}	50	100	200	400	600	800	1000	V
Maximum Average Forward Rectified Current at $T_a = 65\text{ }^\circ\text{C}$	$I_{F(AV)}$	2							A
Peak Forward Surge Current 8.3 ms Single Half Sine Wave Superimposed on Rated Load (JEDEC Method)	I_{FSM}	50							A
Maximum Instantaneous Forward Voltage at 2 A	V_F	1.1							V
Maximum DC Reverse Current at Rated DC Blocking Voltage $T_a = 25\text{ }^\circ\text{C}$ $T_a = 125\text{ }^\circ\text{C}$	I_R	5 50							μA
Typical Junction Capacitance ¹⁾	C_j	20							pF
Typical Thermal Resistance ²⁾	$R_{\theta JA}$	50							$^\circ\text{C/W}$
Operating and Storage Temperature Range	T_j, T_{stg}	-55 ~ +150							$^\circ\text{C}$

1) Measured at 1 MHz and applied reverse voltage of 4 V D.C

2) Thermal resistance from junction to ambient at 0.375" (9.5 mm) lead length, P.C.B. mounted



DSR2A THRU DSR2M

Surface Mount Standard Rectifiers

Characteristic Curves ($T_A=25^\circ\text{C}$ unless otherwise noted)

Fig.1 Forward Current Derating Curve

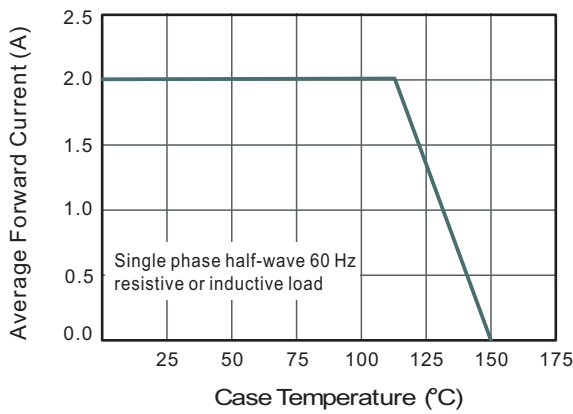

Fig.2 Typical Instantaneous Reverse Characteristics

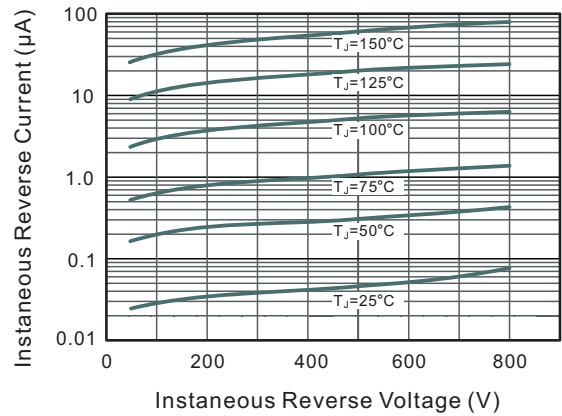

Fig.3 Typical Forward Characteristic

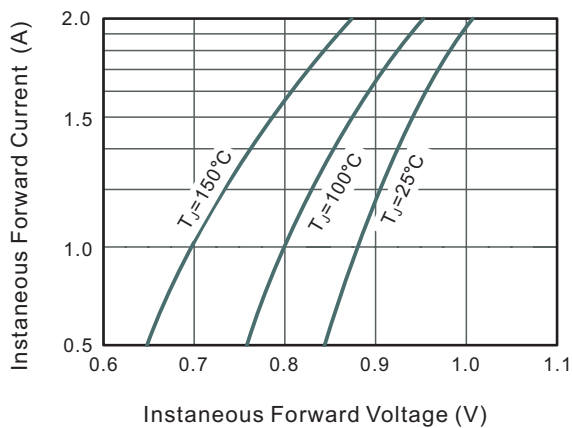

Fig.4 Typical Junction Capacitance

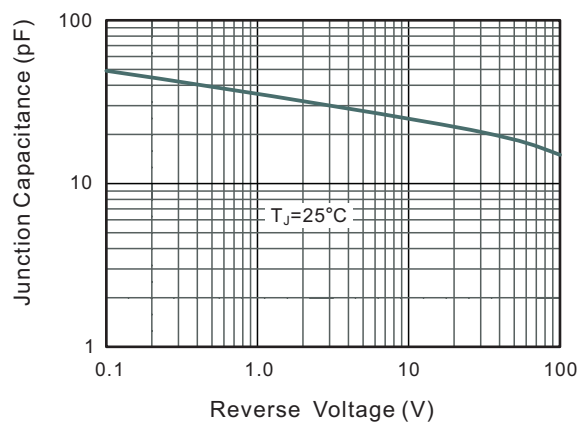
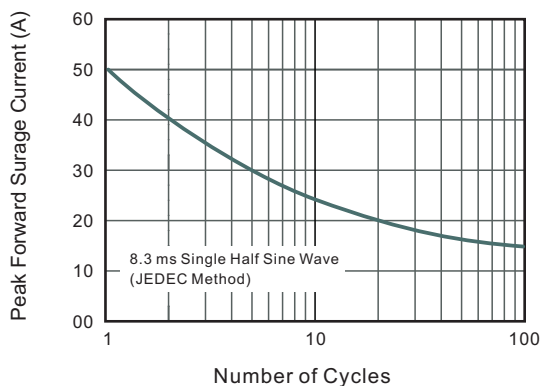

Fig.5 Maximum Non-Repetitive Peak Forward Surge Current





DSR2A THRU DSR2M

Surface Mount Standard Rectifiers

PACKAGE OUTLINE

Plastic surface mounted package; 2 leads

SOD-123FL

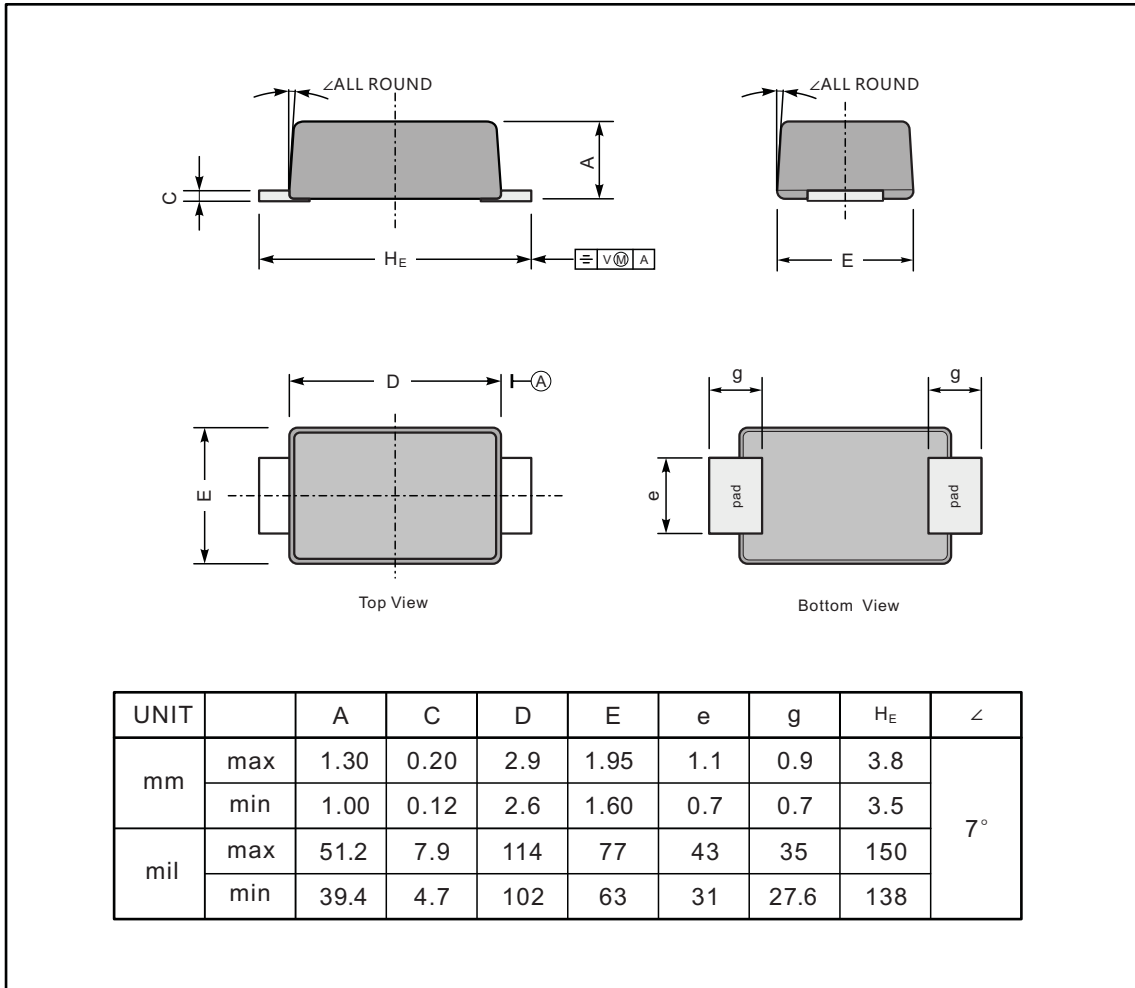

The recommended mounting pad size

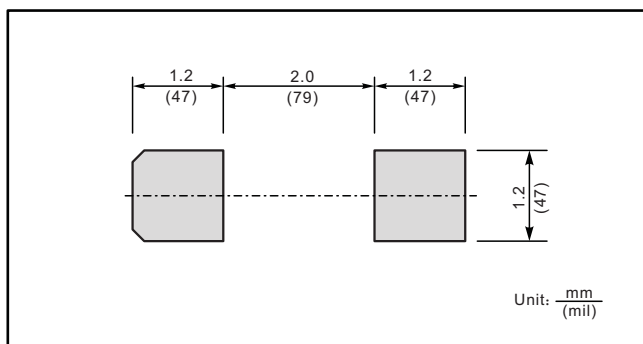

Marking

Type number	Marking code
DSR2A	S2A
DSR2B	S2B
DSR2D	S2D
DSR2G	S2G
DSR2J	S2J
DSR2K	S2K
DSR2M	S2M