

REV.	ECN NO.	LOCATION	DESCRIPTION	DATE	DESIGN
1			INITIAL RELEASE	2018.01.10	Alex_Z

NOTES:  
 PRODUCT MEETS CONTROLLED SUBSTANCES SPEC.  
 1. MATERIAL:  
 1.1 HOUSING: LCP.  
 1.2 TERMINAL: BRASS  
 2. FINISH:  
 2.1 CONTACT:  
 GOLD PLATING(SEE DESCRIPTION) ON CONTACT AREA.  
 80u" MIN. MATTE-TIN PALTING ON SOLDER TAIL AREA.  
 50u" MIN. NICKEL UNDERPLATING OVERALL.

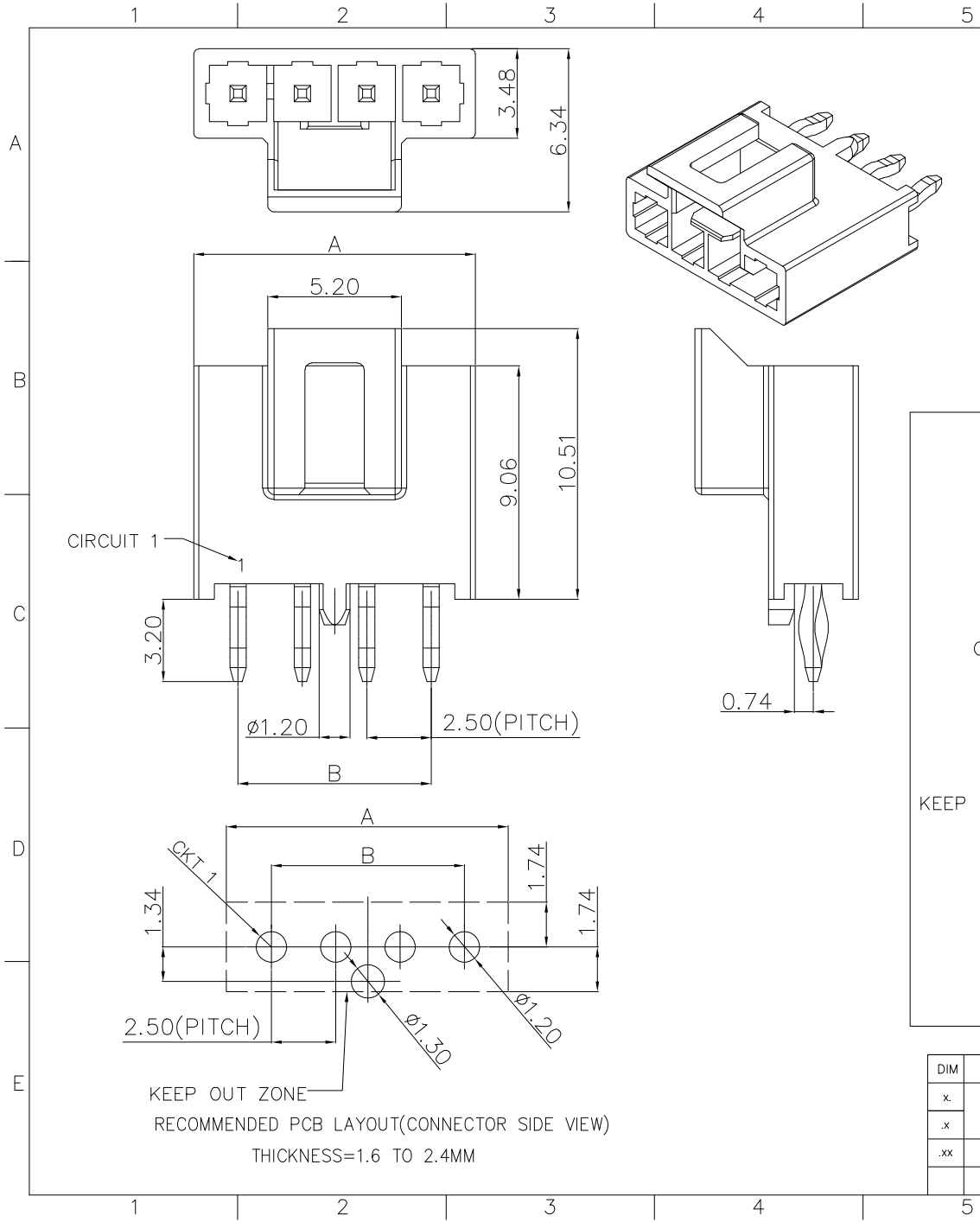

DIM	TOL	DIM	TOL	DEREN		SHENZHEN DEREN ELECTRONIC CO., LTD	
x.	±0.35	x.	±2'	DRAW NO. ***	CUSTOMER DRAWING	DATE	TITLE: HEADER OF NANO-FIT D/R VERTICAL CONSP POWER CONNECTOR
.x			DESIGN:		Alex_Z	2018.01.10	P/N: SEE TABLE
.xx	±0.25				CHECK:		
				REV. 1	APPROVAL:		SHEET: 1/4
							SCALE: N/A UNIT: mm

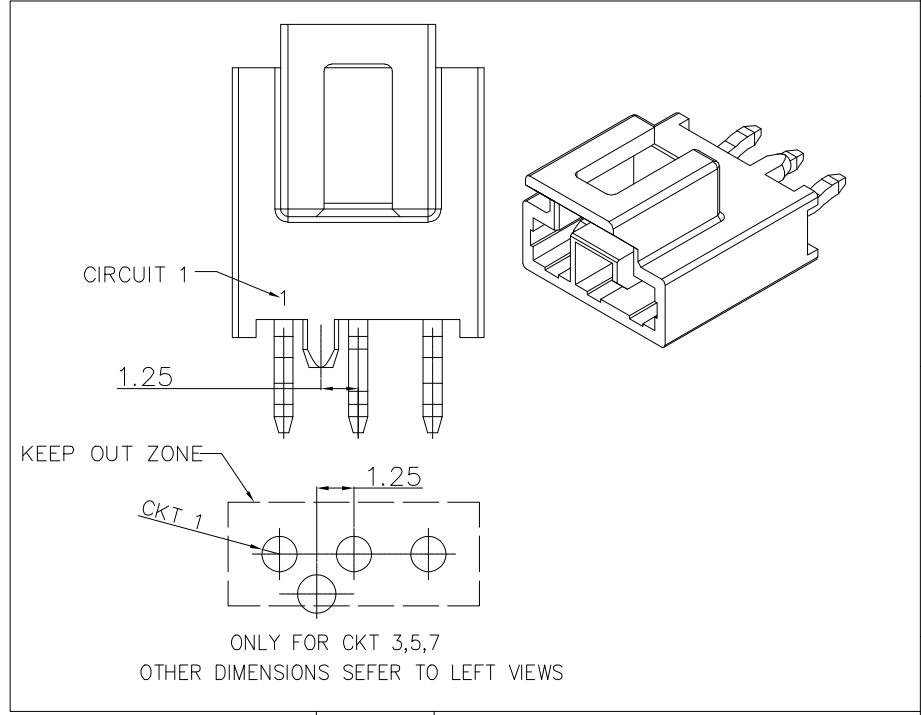
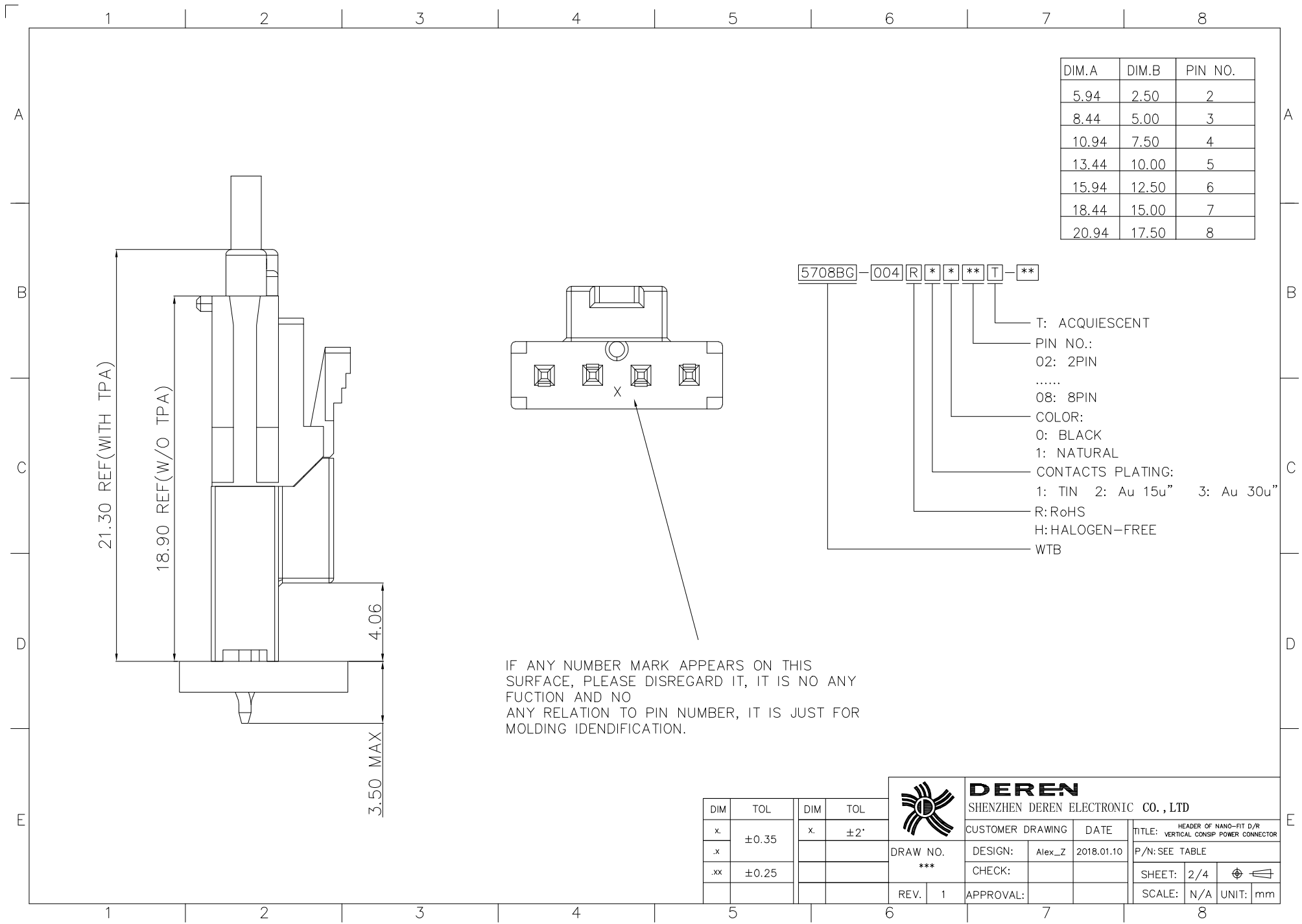

DIM.A	DIM.B	PIN NO.
5.94	2.50	2
8.44	5.00	3
10.94	7.50	4
13.44	10.00	5
15.94	12.50	6
18.44	15.00	7
20.94	17.50	8

5708BG-004R\*\*T\*\*

- T: ACQUIESCENT
- PIN NO.:  
02: 2PIN  
.....  
08: 8PIN
- COLOR:  
0: BLACK  
1: NATURAL
- CONTACTS PLATING:  
1: TIN 2: Au 15u" 3: Au 30u"
- R:RoHS
- H: HALOGEN-FREE
- WTB

IF ANY NUMBER MARK APPEARS ON THIS SURFACE, PLEASE DISREGARD IT, IT IS NO ANY FUCTION AND NO ANY RELATION TO PIN NUMBER, IT IS JUST FOR MOLDING IDENTIFICATION.

DIM	TOL	DIM	TOL
x.	±0.35	x.	±2'
.x			
.xx	±0.25		

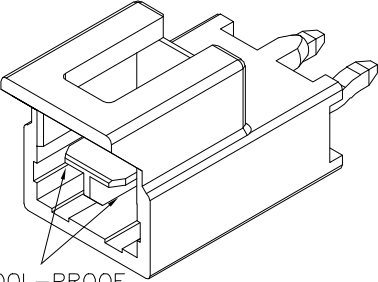
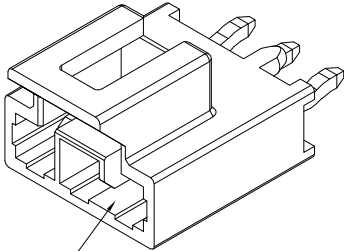
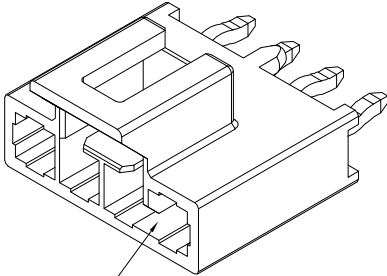
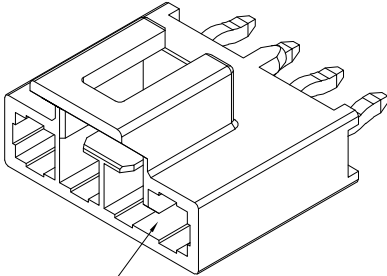
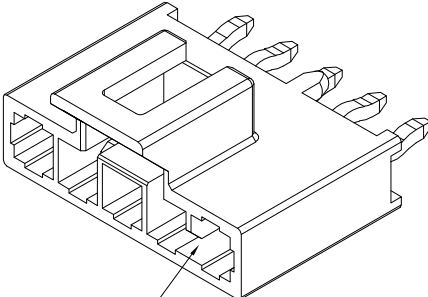
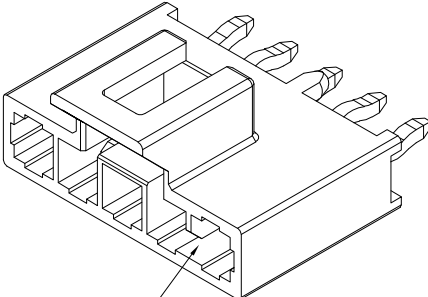
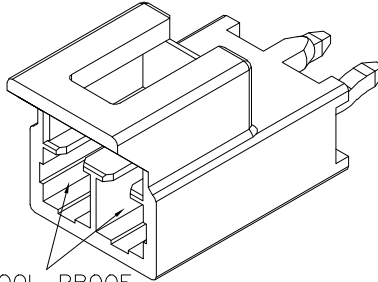
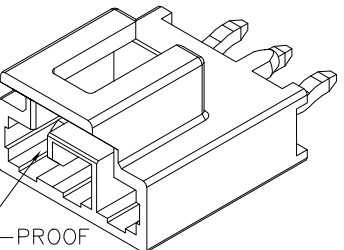
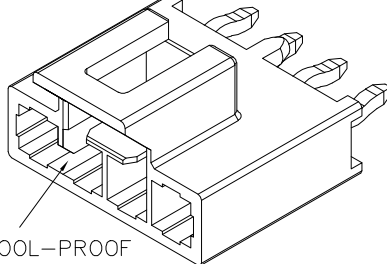
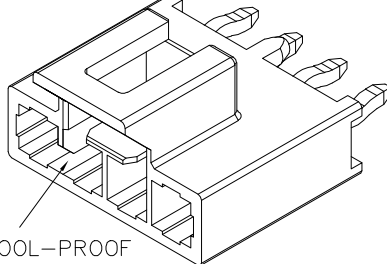
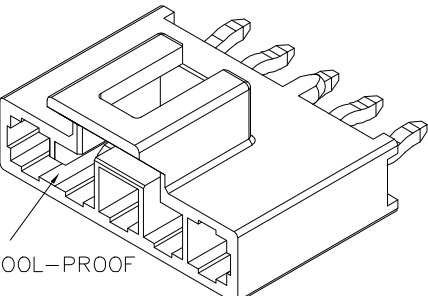
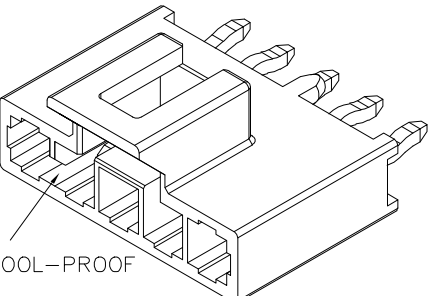

<b>DEREN</b>			
SHENZHEN DEREN ELECTRONIC CO., LTD			
CUSTOMER DRAWING	DATE	TITLE: HEADER OF NANO-FIT D/R VERTICAL CONSP POWER CONNECTOR	
DESIGN: Alex_Z	2018.01.10	P/N: SEE TABLE	
CHECK:		SHEET: 2/4	
REV. 1	APPROVAL:	SCALE: N/A	UNIT: mm

	1	2	3	4	5	6	7	8
A		2 PIN	3 PIN	4 PIN	4 PIN	5 PIN	5 PIN	
B	BLACK							
C								
D	NATURAL							
E								

DIM	TOL	DIM	TOL	 <b>DEREN</b> SHENZHEN DEREN ELECTRONIC CO., LTD	CUSTOMER DRAWING		DATE	TITLE: HEADER OF NANO-FIT D/R VERTICAL CONSP POWER CONNECTOR	
.x	±0.35	.x	±2'		DRAW NO.	DESIGN:	Alex_Z	2018.01.10	P/N: SEE TABLE
.xx	±0.25				***	CHECK:			SHEET: 3/4 
					REV. 1	APPROVAL:			SCALE: N/A UNIT: mm

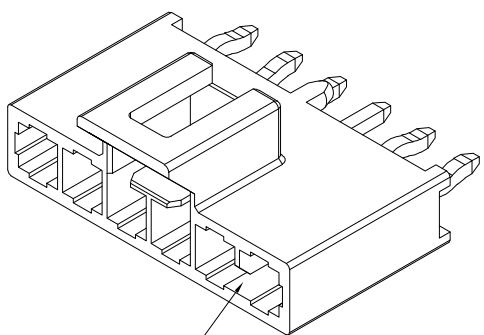
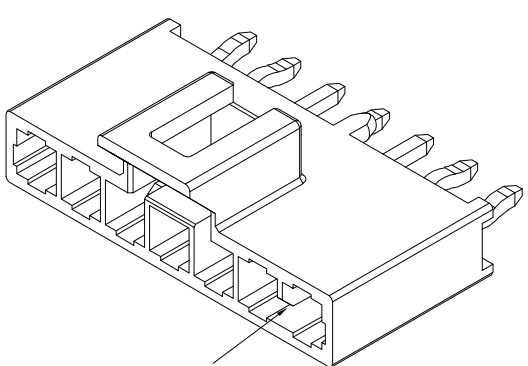
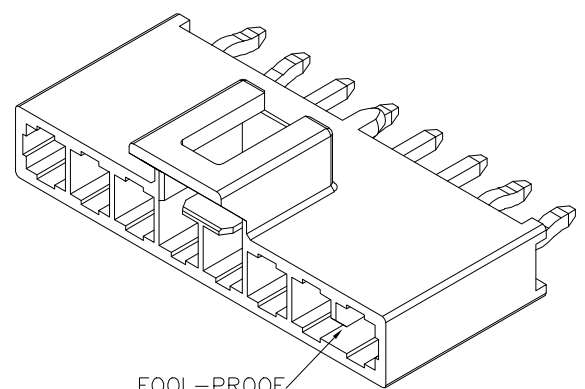
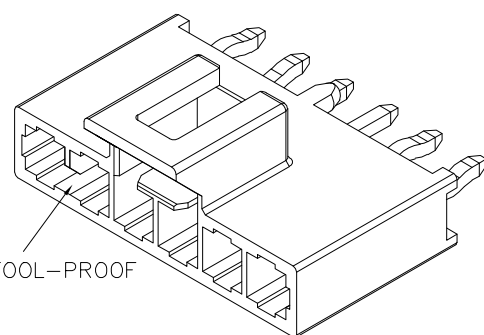
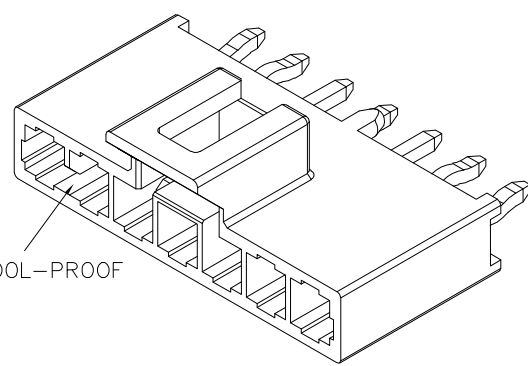
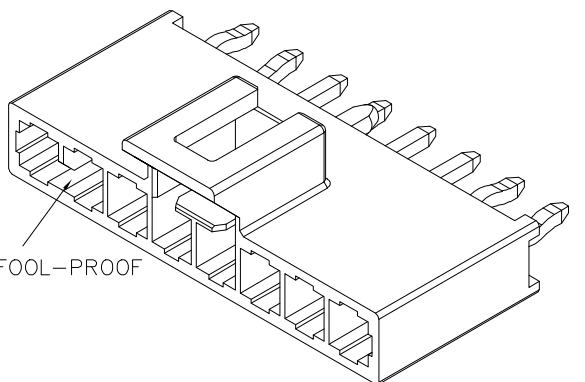
	1	2	3	4	5	6	7	8
A		6 PIN		7 PIN		8 PIN		
B	BLACK							
C		FOOL-PROOF		FOOL-PROOF		FOOL-PROOF		
D	NATURAL							
E		FOOL-PROOF		FOOL-PROOF		FOOL-PROOF		
	1	2	3	4	5	6	7	8

DIM	TOL	DIM	TOL
x.	±0.35	x.	±2'
.x			
.xx	±0.25		

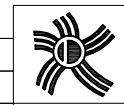

<b>DEREN</b>			
SHENZHEN DEREN ELECTRONIC CO., LTD			
CUSTOMER DRAWING	DATE	TITLE: HEADER OF NANO-FIT D/R VERTICAL POWER CONNECTOR	
DESIGN: Alex_Z	2018.01.10	P/N: SEE TABLE	
CHECK:		SHEET: 4/4	
REV. 1	APPROVAL:	SCALE: N/A	UNIT: mm