

THIS DOCUMENT IS SUBJECT TO CHANGE WITHOUT NOTICE. IT IS CONFIDENTIAL AND A PROPERTY OF AMPHENOL LTW. DISCLOSURE TO THIRD PARTY HAS TO BE AUTHORIZED BY AMPHENOL LTW.

REV.	ECN NO.	DATE	SIGN	DESCRIPTION
A		2020/01/09	Ruru	Initial Released
B	C220463	2022/03/30	Ruru	$\triangle B$ X2

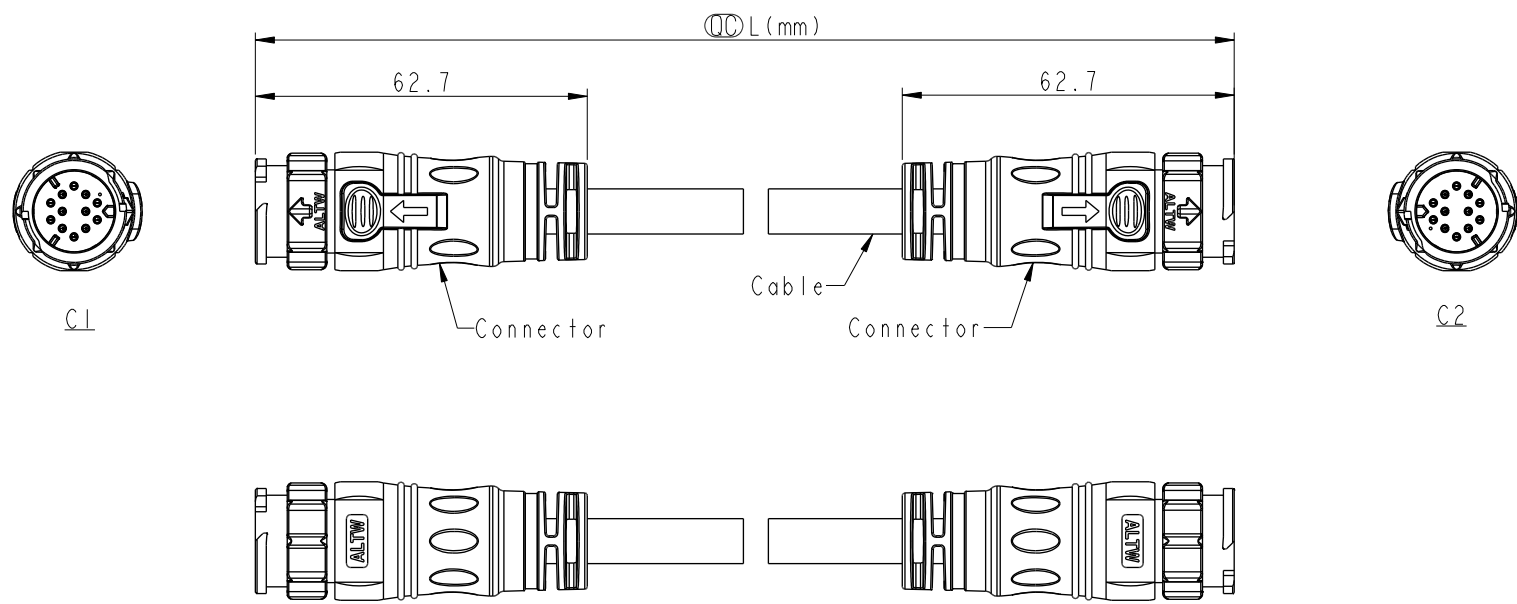

Note: $\triangle B$

- * RoHS Compliant
- * \odot Important dimension
- * Waterproof rate: IPX8, mated 1m/24h
- * Connector
 - Housing: Thermoplastic, Black
 - Pin: Copper Alloy, Gold Plated
 - Outer mold: Thermoplastic, Black
- * Cable: UL21388, PVC Jacket, Black
- * Cable length tolerance:

0.5M < L ≤ 1M:	+60/-0 mm
1M < L ≤ 3M:	+120/-0 mm
3M < L ≤ 5M:	+160/-0 mm
5M < L ≤ 10M:	±100 mm
10M < L ≤ 20M:	±200 mm
20M < L ≤ 30M:	±300 mm
30M < L ≤ 99M:	±500 mm

UNIT:mm			TITLE ACC, XLOK, C-5A, DB-ENDED MM
TOLERANCE ±0.5 mm	SCALE 1:2	SIZE A4	SHEET 1 OF 2
REV. B	WC-REV.	\odot : Inspection item	

Amphenol LTW
安費諾亮泰企業股份有限公司

ITEM NO	DRAWN BY Ruru	DATE 2020-01-09
DWG NO AB-CDXXML-CDML-QDXXX	CHECKED BY Rita	DATE 2020-01-09
CUSTOMER ALTW	APPROVED BY Max	DATE 2020-01-09

THIS DOCUMENT IS SUBJECT TO CHANGE WITHOUT NOTICE. IT IS CONFIDENTIAL AND A PROPERTY OF Amphenol LTW. DISCLOSURE TO THIRD PARTY HAS TO BE AUTHORIZED BY Amphenol LTW.

12P	PVC	8.5	20	AB-CD12ML-CDML-QDXXX
10P		8.5		AB-CD10ML-CDML-QDXXX
9P		7.6		AB-CD09ML-CDML-QDXXX
8P		7.2		AB-CD08ML-CDML-QDXXX
7P		6.8		AB-CD07ML-CDML-QDXXX
Contacts	Cable Jacket	Cable OD	AWG	Item No.

△
XX: No. Of Pin

AB- CD XX M L - CD M L - Q D XXX

XXX: 0.5~99Meters
 A05: 0.5 Meter
 001: 01 Meter
 002: 02 Meters
 :
 099: 99 Meters

Pin Out	Wire	Pin #	Wire	Pin #	Wire	Pin #	Wire	Pin #	Wire	Pin #	Wire
7	Orange 橙	8	Green 綠	9	Brown 棕	10	White 白	12	Light Green 淡綠		
6	Blue 藍	7	Orange 橙	8	Green 綠	9	Gray 灰	11	Pink 粉紅		
8	Green 綠	6	Blue 藍	7	Orange 橙	8	Purple 紫	10	White 白		
4	Yellow 黃	5	Purple 紫	6	Blue 藍	7	Blue 藍	9	Gray 灰		
3	Black 黑	4	Yellow 黃	5	Purple 紫	6	Green 綠	8	Purple 紫		
2	Red 紅	3	Black 黑	4	Yellow 黃	5	Yellow 黃	7	Blue 藍		
1	Brown 棕	2	Red 紅	3	Black 黑	4	Orange 橙	6	Green 綠		
		1	Brown 棕	2	Red 紅	3	Red 紅	5	Yellow 黃		
				1	Gray 灰	2	Brown 棕	4	Orange 橙		
							1	Black 黑	3	Red 紅	
									2	Brown 棕	
									1	Black 黑	

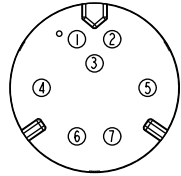
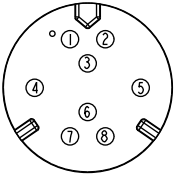
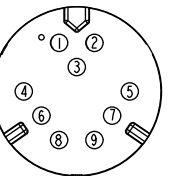
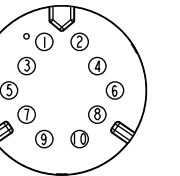
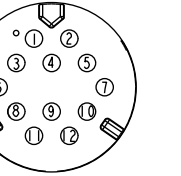
CI & C2	Diagram	Pin #	Wire
		7P	
		8P	
		9P	
		10P	
		12P	

Pin Assignments Front View

UNIT:mm 

TOLERANCE
± 0.5 mm

TITLE
ACC, XLOK, C-5A, DB-ENDED
MM

SCALE 1:2 SIZE A4 SHEET 2 OF 2

REV. B WC-REV. : Inspection item

Amphenol LTW
安費諾亮泰企業股份有限公司

ITEM NO	DRAWN BY	DATE
DWG NO AB-CDXXML-CDML-QDXXX	Ruru	2020-01-09
CUSTOMER ALTW	CHECKED BY Rita	DATE 2020-01-09
	APPROVED BY Max	DATE 2020-01-09