

THIS DOCUMENT IS SUBJECT TO CHANGE WITHOUT NOTICE. IT IS CONFIDENTIAL AND A PROPERTY OF Amphenol LTW. DISCLOSURE TO THIRD PARTY HAS TO BE AUTHORIZED BY Amphenol LTW.

REV.	ECN NO.	DATE	SIGN	DESCRIPTION
A		2021/02/04	Allen	Rev.02 To Rev.A.
B	C210889	2021/04/19	Allen	 XI.

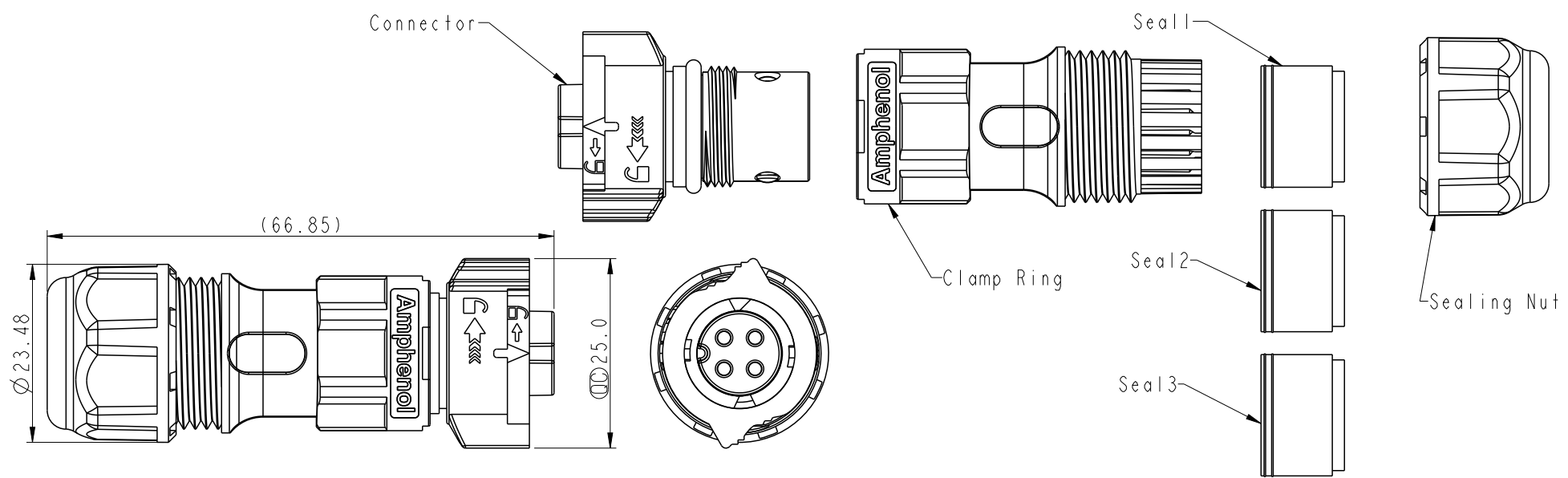

BB-XXBFFB-QL8XPP

02-2Pin  
03-3Pin  
04-4Pin

S: With Red Color Seal 1, Cable OD 5.0~6.0mm.  
M: With Yellow Color Seal 2, Cable OD 6.0~8.0mm.  
L: With Blue Color Seal 3, Cable OD 8.0~10.0mm.  
A: With Seal 1 & Seal 2 & Seal 3.

Note:

- \*  Important Dimension
- \* Waterproof Rate: IPX8, Mated 1m/24h
- \* Housing: Thermoplastic, Black.
- \* Pin: Copper Alloy, Silver Plated.
- \* Clamp Ring: Thermoplastic, Black.
- \* Sealing Nut: Thermoplastic, Black.
- \* Seals: Rubber.
- \* One set unassembled in one PE bag
- \* RoHS Compliant

Pin Assignments Front View

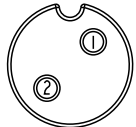

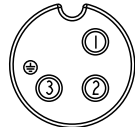

2 Pin

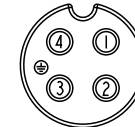

3 Pin



4 Pin

UNIT:mm			TITLE	XLOK, B-10A, CABLE W/O SR F, F, FI SCREW IN, XLOK		
TOLERANCE	±0.5 mm		SCALE	1:1	SIZE	A4
	REV.	B	WC-REV.	A.5	SHEET	1 OF 1
				Inspection item		

# Amphenol LTW

安費諾亮泰企業股份有限公司

ITEM NO	DRAWN BY	Allen	DATE	2021/02/04
DWG NO	CHECKED BY	Wen	DATE	2021/02/04
CUSTOMER	APPROVED BY	Neo	DATE	2021/02/04
ALTW				