

THIS DOCUMENT IS SUBJECT TO CHANGE WITHOUT NOTICE. IT IS CONFIDENTIAL AND A PROPERTY OF AMPHENOL LTW. DISCLOSURE TO THIRD PARTY HAS TO BE AUTHORIZED BY AMPHENOL LTW.

REV.	ECN NO.	DATE	SIGN	DESCRIPTION
E	E191814	2019/10/23	Ruru	$\triangle E$ X3
F	C210786	2021/06/06	Angel Chou	$\triangle F$ X5
G	C220464	2022/04/07	Ruru	$\triangle G$ X4

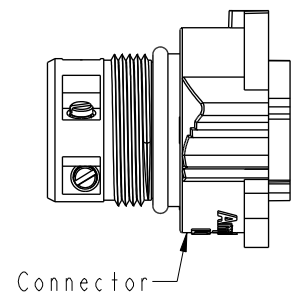
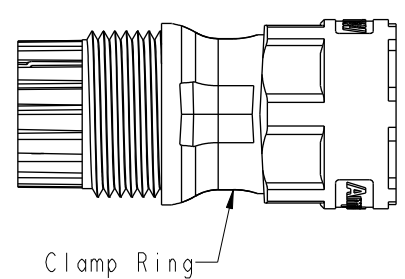
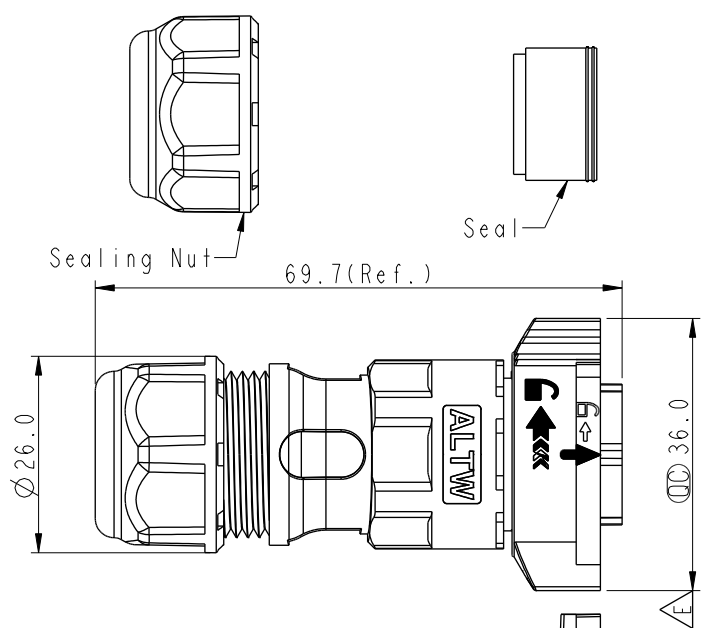

DC-XXBFFB-QL8XPP
 $\triangle C$ $\triangle G$
 XX: No. Of Pin

S: With Red Color Seal 1, Cable OD 8.0~10.0mm.
 M: With Yellow Color Seal 2, Cable OD 10.0~12.0mm.
 L: With Blue Color Seal 3, Cable OD 12.0~14.0mm.
 A: With Seal 1 & Seal 2 & Seal 3.

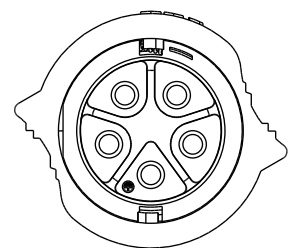
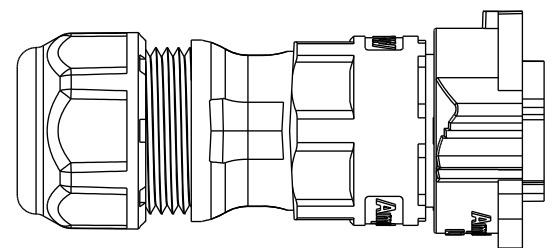

Note: $\triangle E$ $\triangle F$ $\triangle G$
 * RoHS Compliant
 * \varnothing Important dimension
 * Waterproof rate: IPX8, mated 1m/24h
 * Connector
 Housing: Thermoplastic, Black
 Pin: Copper Alloy, Silver Plated
 Nut: Thermoplastic, Black
 O-Ring: Rubber, Dark Gray
 * Clamp Ring: Thermoplastic, Black
 * Sealing Nut: Thermoplastic, Black
 * Seals: Rubber

Pin Assignments Front View

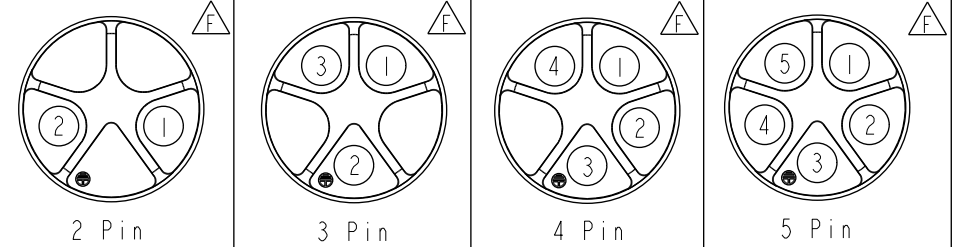

UNIT:mm	\varnothing	\varnothing	TITLE	$\triangle E$	$\triangle G$
TOLERANCE			XLOK, D-20A, CABLE W/O SR		
± 0.5 mm			F, F, FI SCREW IN, PUSH LOCK		
	SCALE	SIZE	SHEET	OF	
	8:5	A4	1	2	
	REV.	WC-REV.	\varnothing : Inspection item		
	G	A.3			

Amphenol LTW
 安費諾亮泰企業股份有限公司

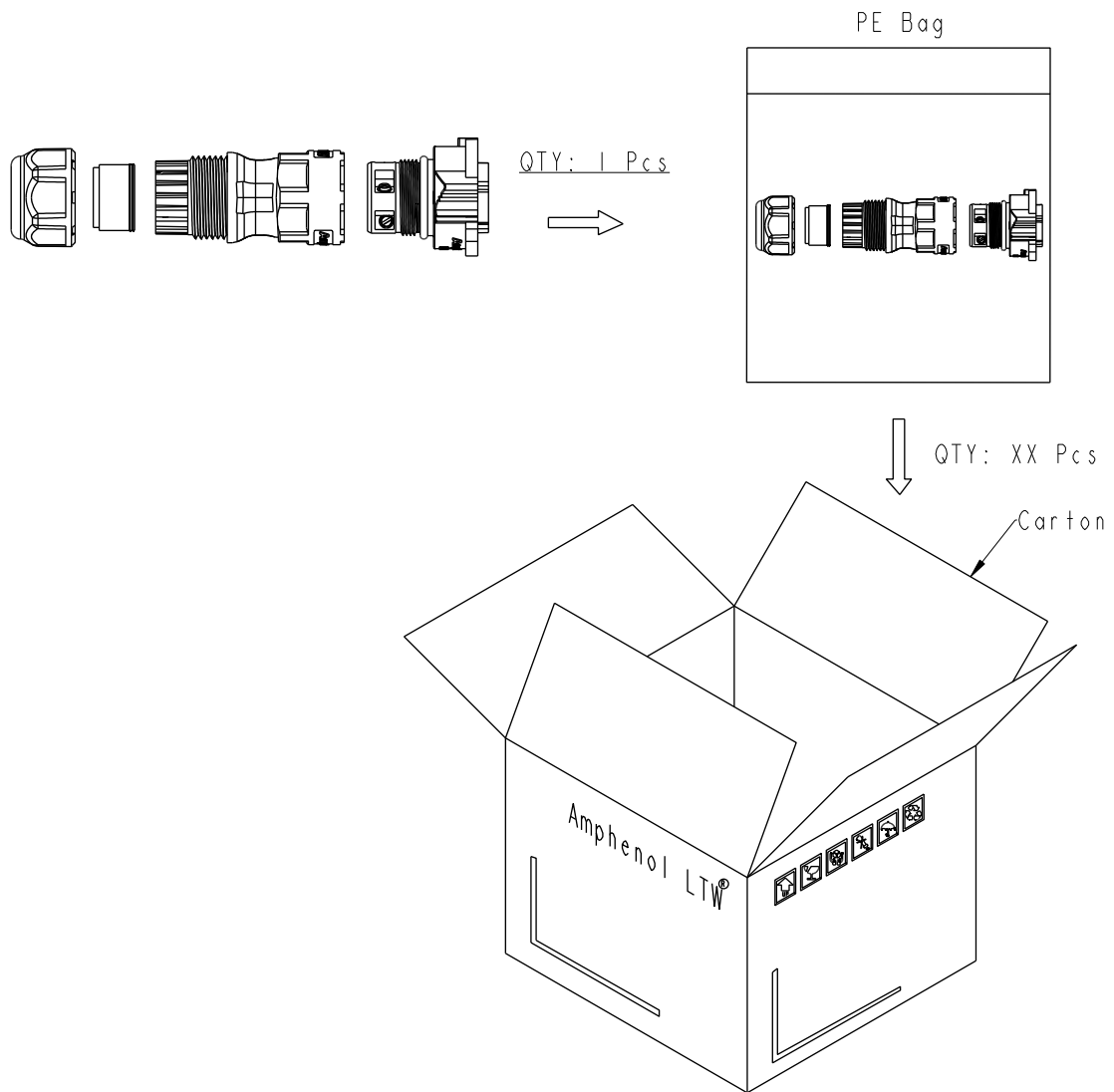

ITEM NO	DRAWN BY	DATE
	Siou	2019-08-02
DWG NO	CHECKED BY	DATE
DC-XXBFFB-QL8XPP	Eagle	2019-08-02
CUSTOMER	APPROVED BY	DATE
ALTW	Neo	2019-08-02

THIS DOCUMENT IS SUBJECT TO CHANGE WITHOUT NOTICE. IT IS CONFIDENTIAL AND A PROPERTY OF Amphenol LTW. DISCLOSURE TO THIRD PARTY HAS TO BE AUTHORIZED BY Amphenol LTW.



Note:
 * One Set Unassembled In One PE Bag.
 (每一組未組裝，放置於一個PE袋，並封口，如圖示)
 * Label is Attached To PE Bag Front.
 (標籤貼在PE袋正面)

UNIT:mm 
 TOLERANCE
 ±0.5 mm

TITLE
 XLOK, D-20A, CABLE W/O SR
 F, F, FI SCREW IN, PUSH LOCK 
 SCALE 8:5 SIZE A4 SHEET 2 OF 2
 REV. G WC-REV. A.3 : Inspection item

Amphenol LTW
 安費諾亮泰企業股份有限公司

ITEM NO	DRAWN BY	DATE
	Siou	2019-08-02
DWG NO	CHECKED BY	DATE
DC-XXBFFB-QL8XPP	Eagle	2019-08-02
CUSTOMER	APPROVED BY	DATE
ALTW	Neo	2019-08-02