

5	6	7	8
REV.	ECN NO.	DATE	SIGN
			DESCRIPTION

THIS DOCUMENT IS SUBJECT TO CHANGE WITHOUT NOTICE. IT IS CONFIDENTIAL AND A PROPERTY OF Amphenol LTW. DISCLOSURE TO THIRD PARTY HAS TO BE AUTHORIZED BY Amphenol LTW.

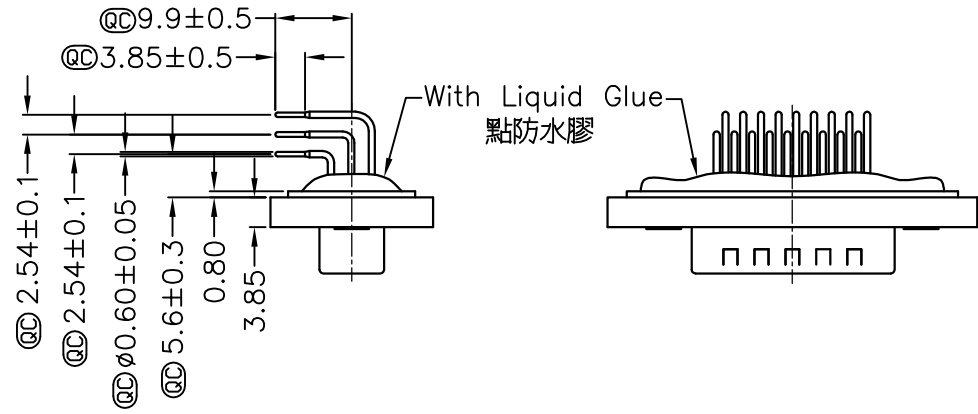

Screw L=5.0 For Panel Thickness Under 1.2mm
適用板厚為1.2mm以下

Screw L=6.0 For Panel Thickness Between 1.2~2.0mm
適用板厚為1.2~2.0mm

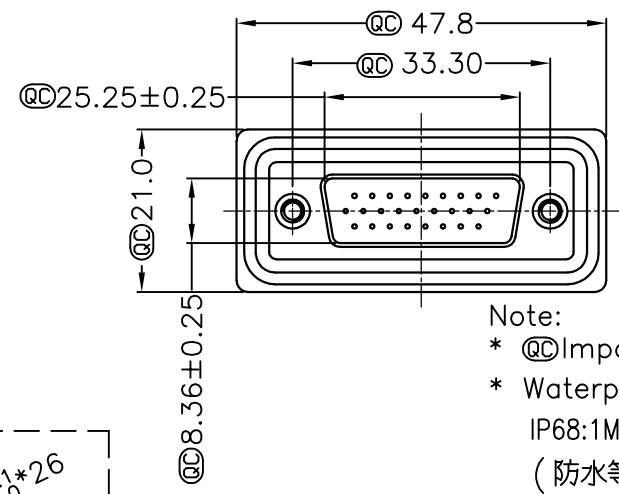
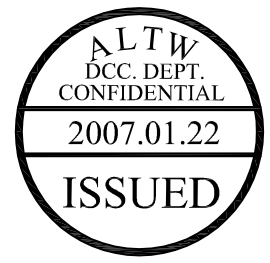

- Note:
- * @@ Important Dimension.
 - * Waterproof Rate : IP68
IP68:1M of depth of water 24 hours
(防水等級 IP68)
(IP68:1米水深 24小時)
 - * Do Mating Test After Glued
點膠後, 須作對插測試
 - * HD-SUB Conn. : Black Core , PBT
 - * Plastic Jacket : Black , Nylon+GF
 - * Pin : Copper Alloy , Gold Plated
 - * Ring : Light Blue, Silicone
 - * Screw : Copper Alloy, Nickel Plated, #4-40 UNC

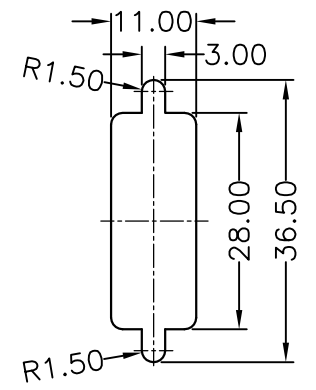

Recommended Panel Cut-Out
建議挖孔尺寸

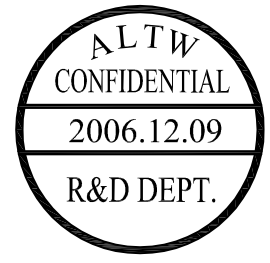
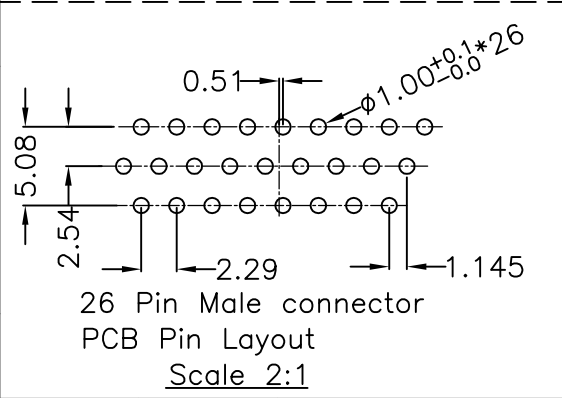
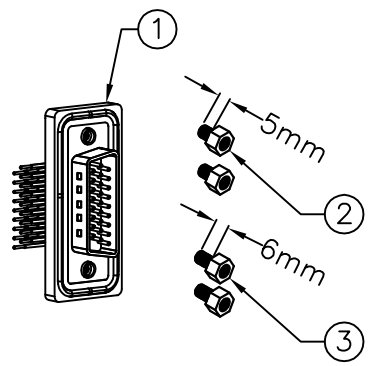

UNIT:mm		TITLE D-SUB Conn.
TOLERANCE .X ±0.25 .XX ±0.1 .XXX ±0.05 ANGLES ±1'	Panel Screw HD26P M Conn. M Pin	SCALE Free SHEET 1 OF 1
REV. A	SIZE A4	@@ : Inspection Item

Amphenol LTW
安費諾亮泰企業股份有限公司

ITEM NO HDB-26PMMP-SR8001	DRAWN BY Gao Ling	DATE 2006/12/09
DWG NO HDB-26PMMP-SR8001	CHECKED BY Simon	DATE 2006/12/09
CUSTOMER ALTW	APPROVED BY Max	DATE 2006/12/09