

THIS DOCUMENT IS SUBJECT TO CHANGE WITHOUT NOTICE. IT IS CONFIDENTIAL AND A PROPERTY OF Amphenol LTW. DISCLOSURE TO THIRD PARTY HAS TO BE AUTHORIZED BY Amphenol LTW.

REV.	ECN NO.	DATE	SIGN	DESCRIPTION
A	Initial Release	2009/04/07	Doreen	Change REV.02 to REV.A
B	LEN1510573	2015/01/15	Sam	Update Logo&Drawing.

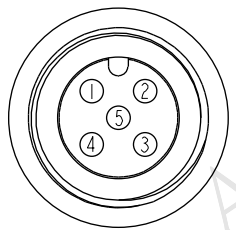

Conn.1  
Pin Assignments  
Front View

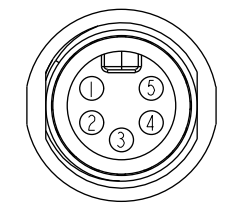
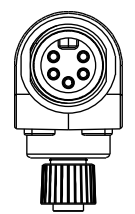

Conn.2  
Pin Assignments  
Front View

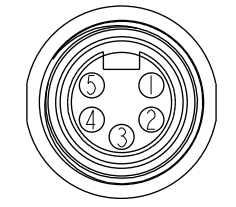

Conn.3  
Pin Assignments  
Front View

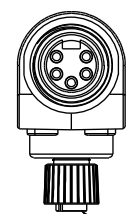
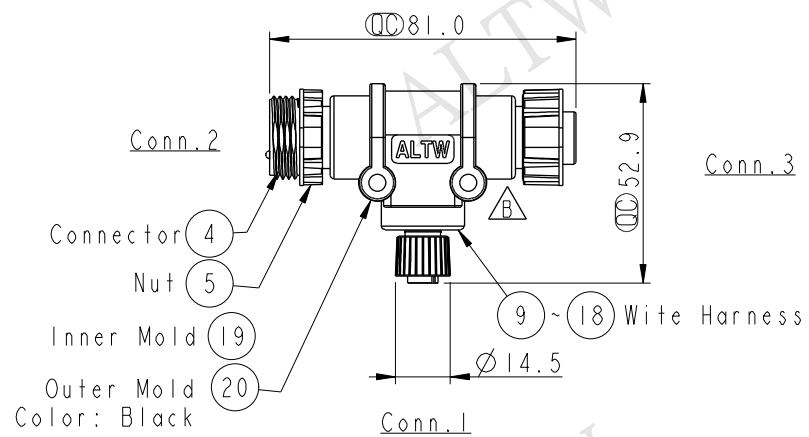

1 Connector  
2 O-ring  
3 Nut

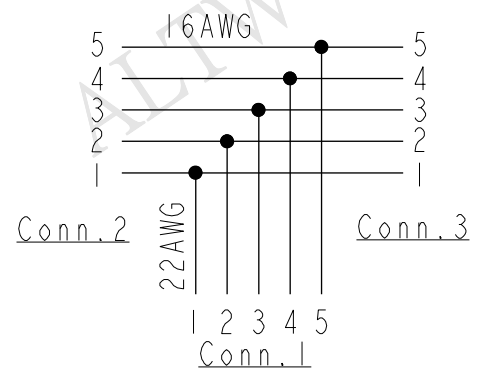
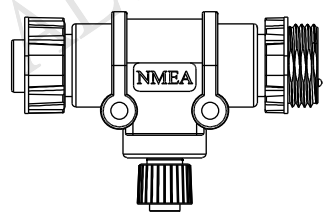

**ALTW**  
CONFIDENTIAL  
2015-01-15  
R&D DEPT.

**ALTW**  
DCC. DEPT.  
CONFIDENTIAL  
2015.01.27  
ISSUED

Blue (16AWG)藍	5	5	Blue (22AWG)藍	5
White (16AWG)白	4	4	White (22AWG)白	4
Black (16AWG)黑	3	3	Black (22AWG)黑	3
Red (16AWG)紅	2	2	Red (22AWG)紅	2
Yellow (16AWG)黃	1	1	Green (22AWG)綠	1
Wire Color	Conn.3	Conn.2	Wire Color	Conn.1

Note:  
 \* (Circled D) Important Dimension.  
 \* Waterproof Rate: IP67.  
 \* Connector: PU, Black.  
 \* Pin: Copper Alloy, Gold Plated.  
 \* O-Ring: Silicone, Gray.  
 \* Nut: Zinc, Nickel Plated.  
 \* Wire Harness: UL1007 16AWG & UL1007 22AWG

UNIT:mm	
TOLERANCE	±0.5 mm

TITLE Mini- Micro T Adaptor Screw FMF Conn FMF Pin			
SCALE 1:2	SIZE A4	SHEET 1 OF 1	
REV. B	WC-REV. A.1	QC: Inspection item	

**Amphenol LTW**  
安費諾亮泰企業股份有限公司

ITEM NO UNC-050505-FMF-TS001	DRAWN BY Sam	DATE 2015-01-15
DWG NO UNC-050505-FMF-TS001	CHECKED BY Vicky	DATE 2015-01-15
CUSTOMER ALTW	APPROVED BY Rita	DATE 2015-01-15